

SEASON: TWENTY-ONE
YEAR: 2025/26

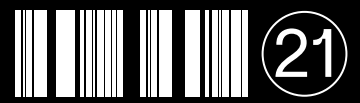

DESIGNED → TESTED →
ENGINEERED IN ITALY

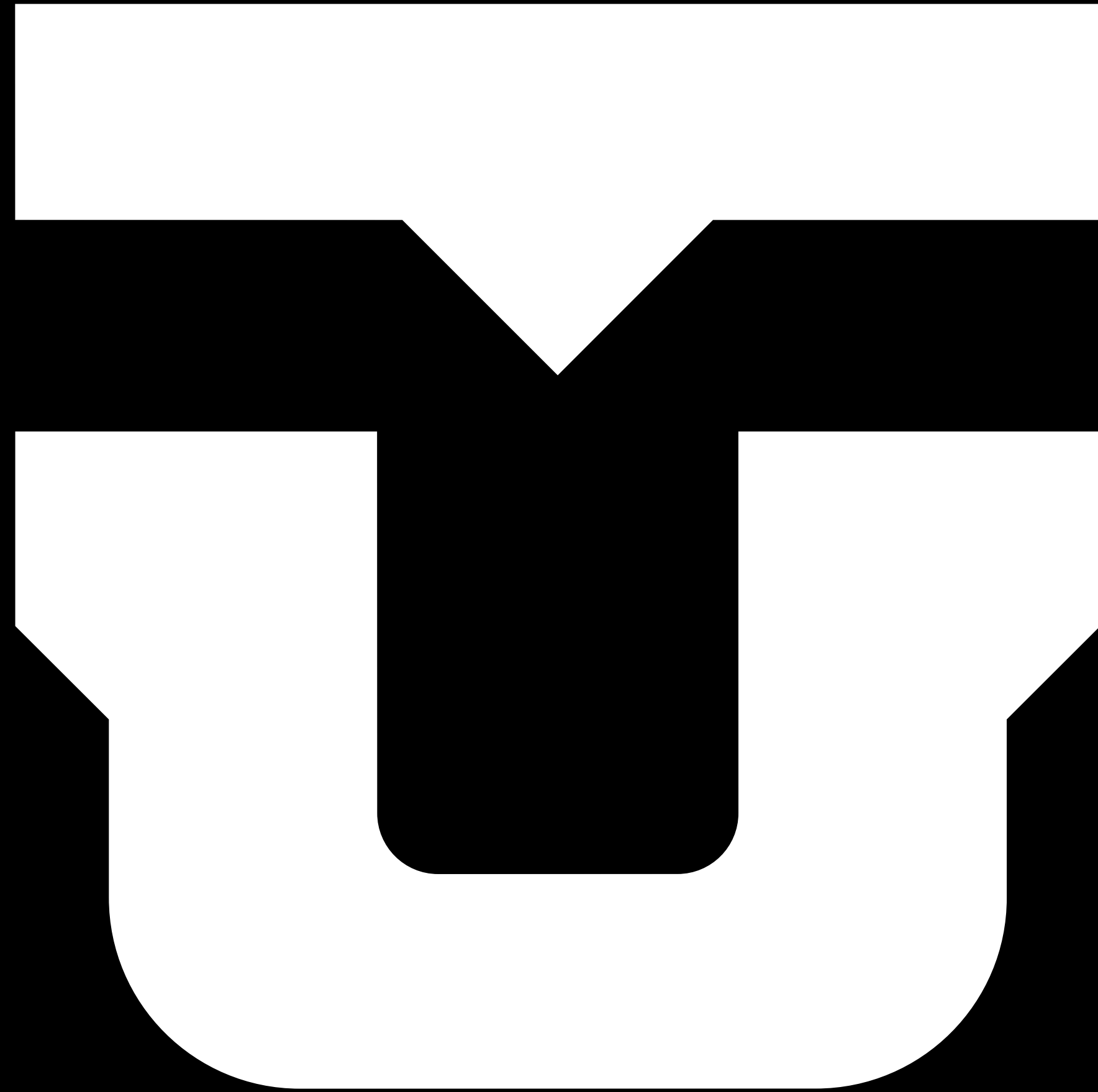
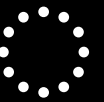

STRONGER.
@UNIONBINDINGCO

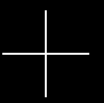

© COPYRIGHT CORE SRL
ALL RIGHTS RESERVED

SEASON 21: A BOLD NEW FUTURE



UNLOCKING POSSIBILITIES

Twenty years ago, Union Binding Company was founded on the idea of a simple, yet ambitious mission: to create the best-fitting, highest-performing, and most durable snowboard bindings the world has ever seen. Since our humble beginnings in 2004, Union has evolved into the global leader in snowboard bindings by relentlessly pushing the boundaries of innovation, performance, and design.

What truly sets Union apart is our refusal to settle for the status quo. We are constantly thinking of ways to improve the snowboarding experience, challenging ourselves to think beyond the present and the tangible, pushing the boundaries of what's possible, and unlocking new possibilities. For us, the journey of innovation never ends.

Season 21 marks a bold new chapter for Union, setting the stage for the next two decades ahead of us. We believe that ideas, determination, and people are the core of who we are today and the driving force behind where we're headed tomorrow.

Welcome to Season 21. Welcome the future of Union.



DESIGN & ENGINEERING



RESEARCH & DEVELOPMENT

FULL CIRCLE

CONSTANT PROGRESSION

Season 21 is all about connecting the dots for Union. With the addition of the Union Boot Division, the Union product circle is now complete. Although our product offering is evolving, our goal remains the same. Union has always been focused on building products to elevate the riders' on-snow experience.

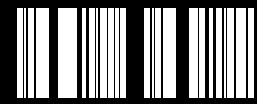

MANUFACTURING



PEOPLE

ASSEMBLY →

PRODUCTION →

MATERIALS →

ENGINEERING →

DESIGN →

TESTING →



SINCE 2004 ©
46°08—09—N 9°22—18—E



Rider: Austin Visintainer | Photo: Brendon Rego



TABLE OF CONTENTS

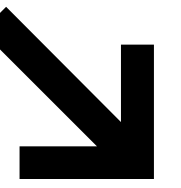

Union Boot Division UBD 005

UBD →	005
Reset Pro	015
Reset Pro Overview	016

Union Lab LAB 018

LAB →	018
Source FC	027
Source FC Overview	028
Source Pro	029
Source Pro Overview	030

Union Step On® uso 031

STEP ON® →	031
Atlas Step On®	038
Step On® Overview	039

Union Binding Company UBC 041

PERFORMANCE →	046	ALL MOUNTAIN →	055	FREESTYLE →	070	KIDS →	088
Falcor	047	Force	056	Ultra Men's	071	Cadet Pro	089
Atlas Pro	049	Trilogy	059	Ultra Women's	074	Cadet	091
Atlas	052	Force Classic	061	Strata	077	Cadet Mini	093
Performance Overview	054	Trilogy Classic	063	Legacy	079	Cadet One	095
		STR	065	Flite Pro	081	Kids Overview	097
		Juliet	067	Rosa	083		
		All Mountain Overview	069	Flite	085		
				Freestyle Overview	087		
EXPEDITION →	098	RENTAL →	106	ACCESSORIES →	110		
Charger Pro	099	Rental	107	Softgoods	111		
Charger	101	Rental Overview	109	Bags	114		
Explorer	103			Expedition + Rover	116		
Expedition Overview	105			Tools	118		
				Stickers + Stomp Pads	119		
				Replacement Parts	120		
				Dealer Bulk Parts	122		

Support sos 124

SUPPORT →	124		
Boot Size Chart	125	Binding Size Chart	127
Boot Glossary	126	Binding Disk Guide	128
		Binding Glossary	129
		Warranty + Installation	130
		Online Support	131
		Product Overview	132



"THE FUTURE IS
ABOUT SETTING
HIGHER STANDARDS
AND CONSTANTLY
CHALLENGING
WHAT'S POSSIBLE."

— JAMIE ANDERSON



Rider: Jamie Anderson | Photo: Duncan Sadava



UNION BOOT

DIVISION



25.26



UBD

CORE SRL®
45°46'31"N - 12°02'20"E
Via Cal Trevisana, 6
31044 Montebelluna TV, Italy

STRONGER.

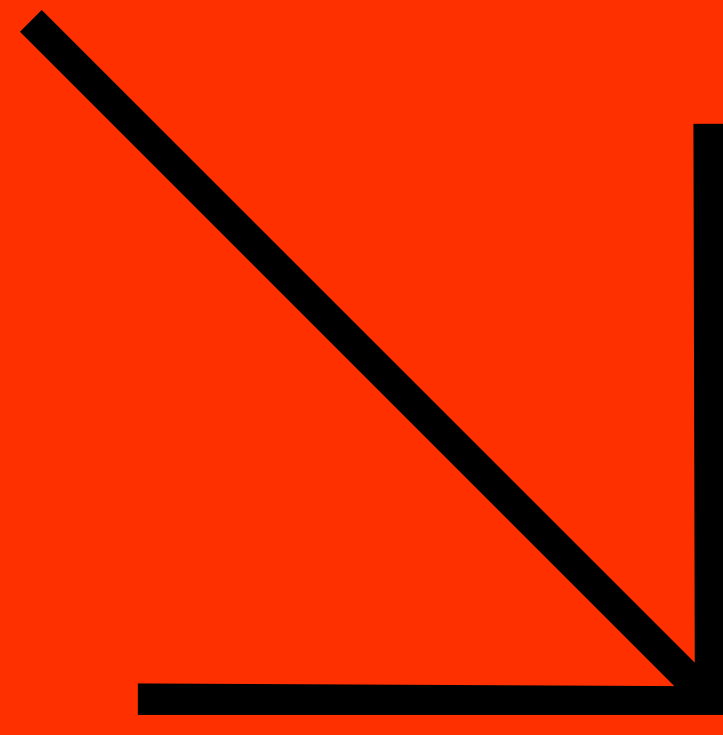

UNION BOOT DIVISION ↔

As lifelong snowboarders with decades of combined product and manufacturing experience, we felt that none of the global brands had nailed the perfect combination of production processes, fit, function, durability, and material innovation. So we got to work.

The team at Union has set a foundation for the world's most advanced snowboard boot ever developed. We've invested heavily in industry leading R&D, streamlined production processes, new machinery, materials, and people.

Our goal is simple: We aim to transform the snowboarding experience by building the world's best snowboard boots.



Our Mission ↘

Transform the snowboarding experience by building the world's best snowboard boots.

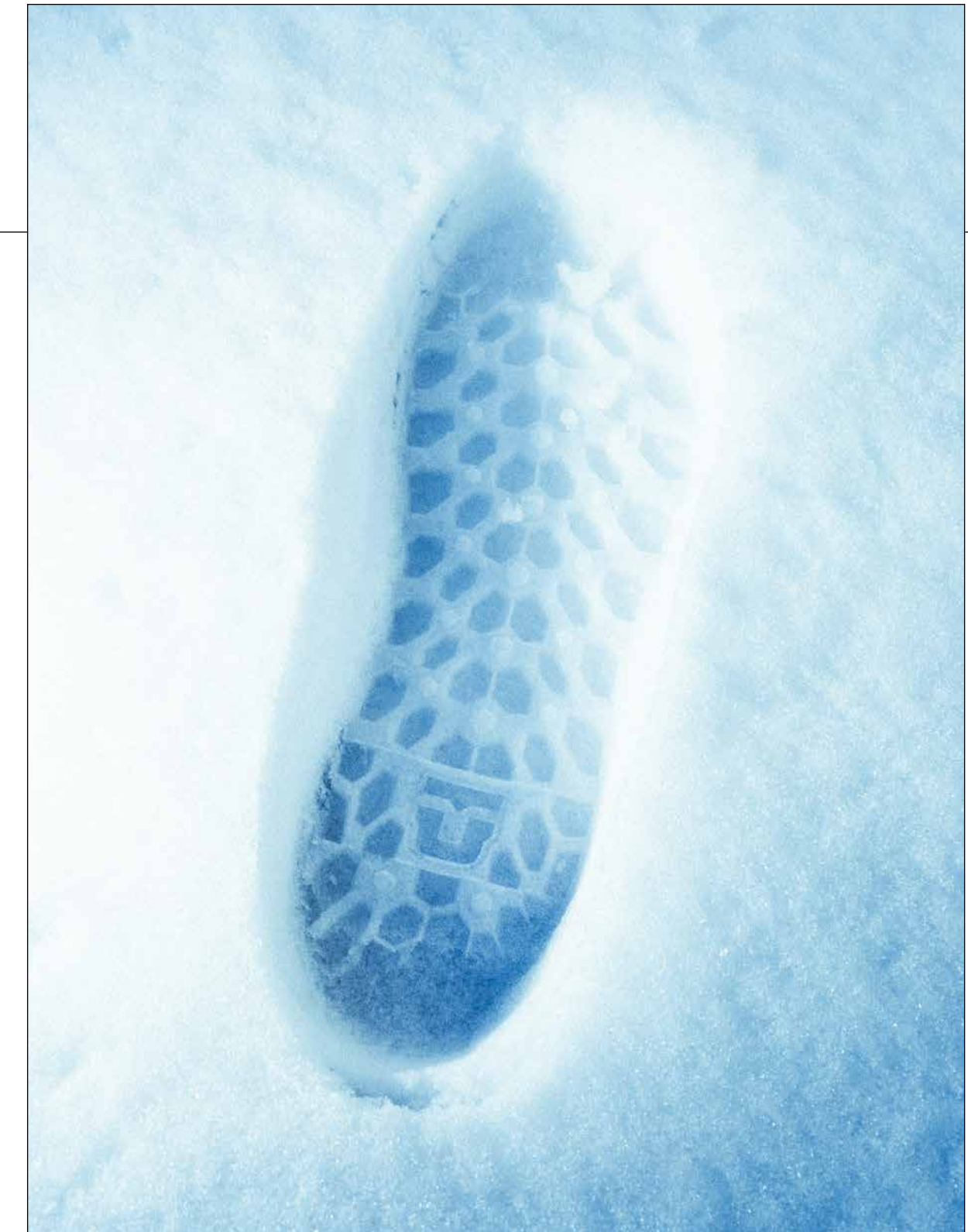

BACK TO MONTEBELLUNA →

CRAFTSMANSHIP + INNOVATION ↔

When you think of the world's leading design center for outdoor footwear, you can only think of one place—Montebelluna, Italy. For generations Montebelluna has been the leader in alpine boot craftsmanship and innovation. When we decided to invest in the boot category, there was no other option than right here in our own backyard.

Inside of the new Union Boot Division headquarters we control 100% of the product design, production process, and supply chain. By vertically integrating all our processes under one roof, we drastically lower production time of our boots while maintaining direct visibility over product quality. With decades of experience in snowboard specific materials, we can share materials between boots and bindings to easily surpass MOQ's while using exclusive materials not available to other brands.

2024

YEAR FOUNDED

1

EXCLUSIVE PATENTED DESIGN

100%

CONTROL OF THE PROCESS





MONTEBELLUNA : ITALY
45°46-31-N — 12°02-20-E



UBD—MFG

THE ONLY SNOWBOARD BOOT MADE IN ITALY



UBD MANUFACTURING

- ① All-new factory.
- ② 100% owned and operated by Union.
- ③ Made with exclusive patented design.
- ④ State of the art assembly process.

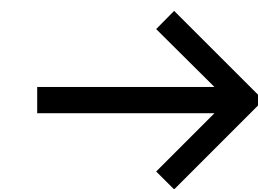
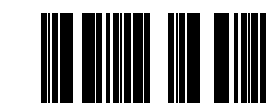



UNION BOOT DIVISION

U



RESET
PRO

MADE IN ITALY

COMING 2025

MONTEBELLUNA
45°46-31-N - 12°02-20-E



RESET PRO

[01]

SINGLE FRAME SHELL™

Patented Union Design
Unique Assembly Connection Point
Durable + Lightweight Pebax Material
Maintains Performance & Flex Over Product Lifecycle

[02]

BOA® FIT SYSTEM FT. H4

High-Power Dial Activated Fit System
Remote Dial Controls Closure of Lower Zone
Precision Fit + Fast Release

[03]

REBOUND BUSHING SYSTEM™

Lightweight Cushioning
Rebound For Heavy Impacts
Increased Board Feel

[04]

X-GRIP OUTSOLE

Lightweight + Durable
Excellent Grip On Snow and Ice
Minimal Thickness For Increased Board Feel



[05]

FORMA PRO LINER

100% Custom Union Liner
Anatomical EPDM Heel Hold
Maximum Comfort + Performance

[06]

BOA® FIT SYSTEM FT. H4 COILER™ + TX3 LACE

High-Power Dial Activated Fit System
Tongue Dial Controls Closure of Upper Zone
Precision Fit + Fast Release
Ultra Tough Lace

[07]

REACT TAPERED 3D TONGUE

Geometric Shaping Designed for Comfort
Increased Room In Toe Box

[08]

HF PREMIUM SYNTHETICS

Wear Resistant
Welded Construction
Locally Sourced In Italy



RESET PRO → KEY FEATURES



1 SHELL

SINGLE FRAME SHELL™

Union's patented Single Frame Shell™ is an industry first and the key to success in Union's all-new streamlined boot assembly process. Lightweight, super durable, waterproof Pebax material provides a reactive flex pattern while snowboarding and maintains its performance over the boots' lifecycle. This 100% new technology offers unmatched durability and performance compared to traditional snowboard boot construction.



[1.1]

REACTIVE FLEX PATTERN

Maintains Performance Over Product Lifecycle

[1.2]

LIGHTWEIGHT PEBAX MATERIAL

Durable + Waterproof

[1.3]

SINGLE STITCH LINE

Streamlined Assembly Point + Increased Durability

[1.4]

ANATOMICAL ANKLE SHAPE

Performance Fit and Heel Hold

[1.5]

UNIQUE ASSEMBLY CONNECTION POINT

Streamlined Assembly Point + Glue Reduction



RESET PRO → KEY FEATURES



LINER

FORMA PRO LINER

Built from the ground up, Union's Forma Pro Liner is the first thing you'll notice when you lace up your boots and the last thing you'll be thinking about while you're riding. This 100% custom-made memory foam liner form fits to any foot out of the box and provides the support and performance that riders need for multiple 100+ day seasons.

FORMA PRO

[2.1]

QUICK-LOCK LACE HARNESS

Easily Adjusts To Your Desired Fit



[2.2]

EPDM TONGUE

Cushioned Memory Foam Material
Added Comfort and Support



[2.3]

EPDM ANKLE POCKET

Cushioned Memory Foam Material
Anatomical Shape Locks Heel In Place
Added Support



[2.4]

HEAT REFLECTIVE FOIL

Redirects Heat Underfoot



RESET PRO → KEY FEATURES

③

③ FOOTBED



CONTACT FOOTBED

Contact 3D formed Dual Density Ortholite™ footbeds deliver a combination of performance and comfort unmatched by any insole manufacturer. Unlike traditional foam, Ortholite™ foam compresses less than 5% over the life time of the product, so the cushioning, fit, comfort and performance never change. Made with 5% recycled rubber.



④ BUSHING SYSTEM



REBOUND BUSHING SYSTEM™

The secret weapon hiding inside of every pair of Union snowboard boots. Union's Rebound Bushing System™ adds an additional layer of lightweight cushioning under your heels and toes to help reduce vibrations for the snow and eat up heavy impacts while riding. This unique layer of rebounding foam [1] paired with our phylon EVA midsole [2] helps to reduce foot fatigue and never loses shape or performance over time.

⑤ OUTSOLE



X-GRIP OUTSOLE

Union X-Grip Outsole is made with durable high performance natural rubber and provides excellent grip on snow and ice. Compared to other outsoles currently available on the market, Union's innovative new design features minimal thickness for increased board feel and riding performance.



RESET PRO → KEY FEATURES

4

6 LACING SYSTEM



7 DIALS



TONGUE DIAL
H4 Coiler™



REMOTE DIAL
H4

8 LACE



DUAL ZONE BOA®

Dual Zone BOA® lacing offers premium all mountain performance with two separate micro-adjustable zones. The tongue dial [1] controls the lace that tightens the upper zone to provide flex and stability, while the remote dial [2] adjusts lace tension and locks in the forefoot for greater response and control in the lower zone.



BOA® FIT SYSTEM FEATURING H4 COILER™ + H4

Rigorously tested and trusted. The BOA® Fit System featuring Dual-Dial H4 delivers revolutionary durability, micro-adjustable, precision fit, and fast release. Dial in your perfect fit.

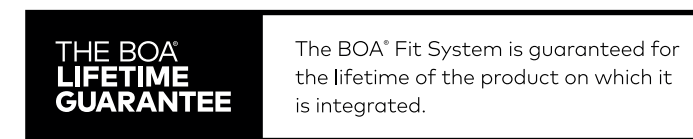

BOA® TX3 LACE

The workhorse of the BOA® Fit System, BOA® laces routinely tolerate the toughest environments and field tests, and are expertly configured for precision and performance. Flexible and low-friction, the BOA® textile TX3 lace delivers high strength-to-weight ratio.



Reset Pro / Snowboard Boot



Product Description

Reset your mind. This is the future of modern snowboard boot design, production processes, fit, function and durability. Join the revolution, reset everything you know about snowboard boots, and transform your snowboarding experience. Introducing the Reset Pro from Union Boot Division, the only snowboard boot made in Italy. Designed for performance driven snowboarders.

Key Features

- High Performance Ride Feel
- Unmatched Out-of-the-Box Comfort
- Unbeatable Durability and Function
- Reduced Boot Profile

Boot Performance

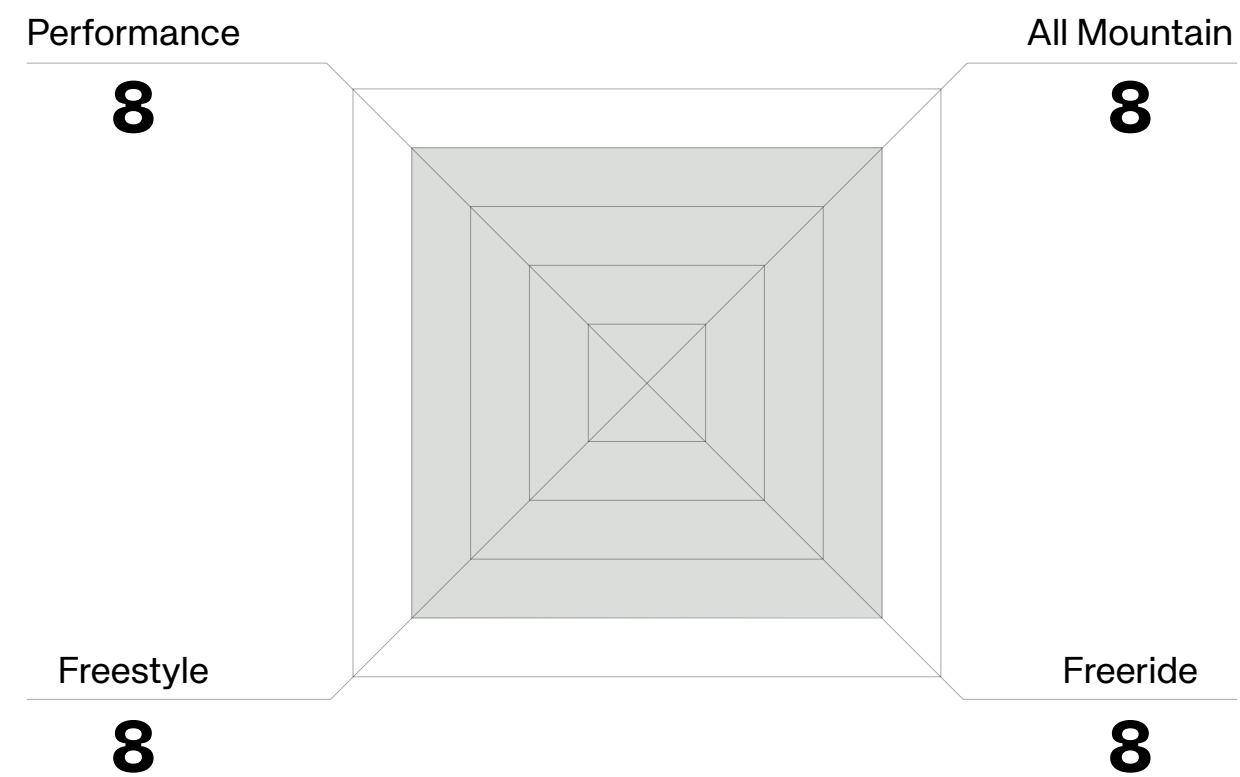

Boot Flex: 7/10



Boot Sizes

US/MEN	7	7.5	8	8.5	9	9.5	10	10.5	11	11.5	12	12.5
UK	6	6.5	7	7.5	8	8.5	9	9.5	10	10.5	11	11.5
EU	40	40.5	41	41.5	42	42.5	43	43.5	44	44.5	45	45.5
MONDO	25	25.5	26	26.5	27	27.5	28	28.5	29	29.5	30	30.5

Technology

LACING SYSTEM:	Dual Zone BOA®	●
BOA® FIT SYSTEM:	BOA® H4 COILER™ + H4	●
LACE:	BOA® TX3 Lace	●
LINER:	Forma Pro	●
SHELL:	Single Frame Shell™	●
FOOTBED:	Contact Dual Density Ortholite™	●
BUSHING:	Rebound Bushing System™	●
MIDSOLE:	Phylon EVA	●
OUTSOLE:	X-Grip Natural Rubber	●
TONGUE:	React Tapered 3D	●
UPPER MATERIAL:	HF Premium Synthetic Ripstop	●
HEEL HOLD:	Thermoformed EPDM Ankle Pockets	●
MOISTURE WICKING:	Mesh Liner	●
HEATING:	Heat Reflective Foil Underfoot	●

New





01.

Color: **Black**
Size: **US M 7-12.5**



02.

Color: **White**
Size: **US M 7-12.5**



Angle: Back 3/4

Reset Pro

Colorways: 02 ● ○



THE ONLY
SNOWBOARD BOOT
MADE IN ITALY.
COMING 2025.

UNION BOOT DIVISION



RESET YOUR MIND.



UNION

LAB

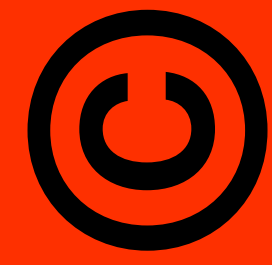

25.26



CORE SRL®
46°08-09-N 9°22-18-E
Via Colombano, 10
23014 Delebio SO, Italy

ADVANCED R&D

LAB

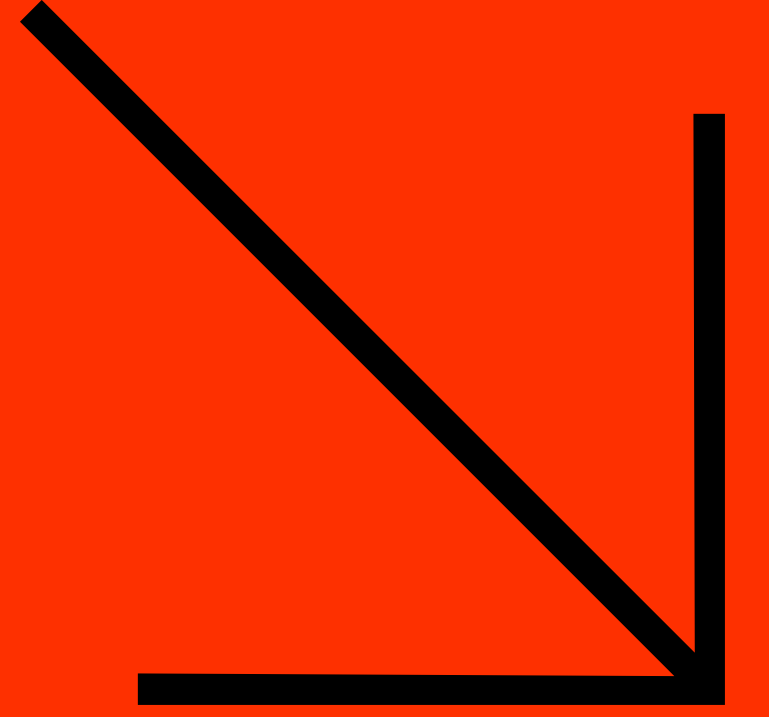



CONCEPTUALIZED IN THE ITALIAN ALPS.
RIDDEN AROUND THE GLOBE.

Union Lab ↘

Established in the year 2024, the Union Lab was created to push the limits of traditional design, engineering, and technology to new levels.

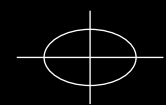

COLICO:ITALY
46°08'09"N 9°22'18"E
STRONGER™



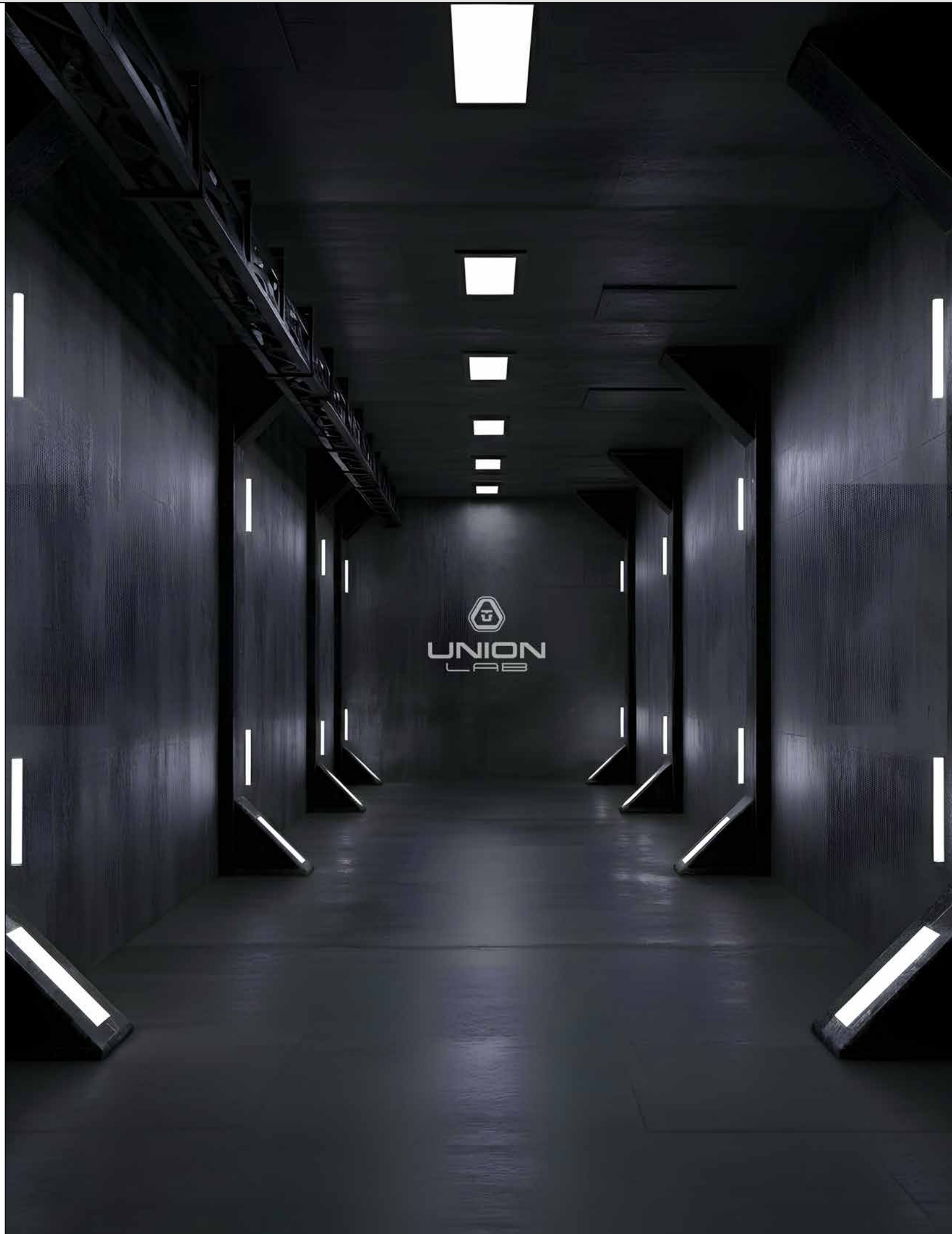

COLICO:ITALY
 46°08—09—N 9°22—18—E
 STRONGER™



THE LAB™

CONCEPTUALIZED IN THE ITALIAN ALPS.
 RIDDEN AROUND THE GLOBE.

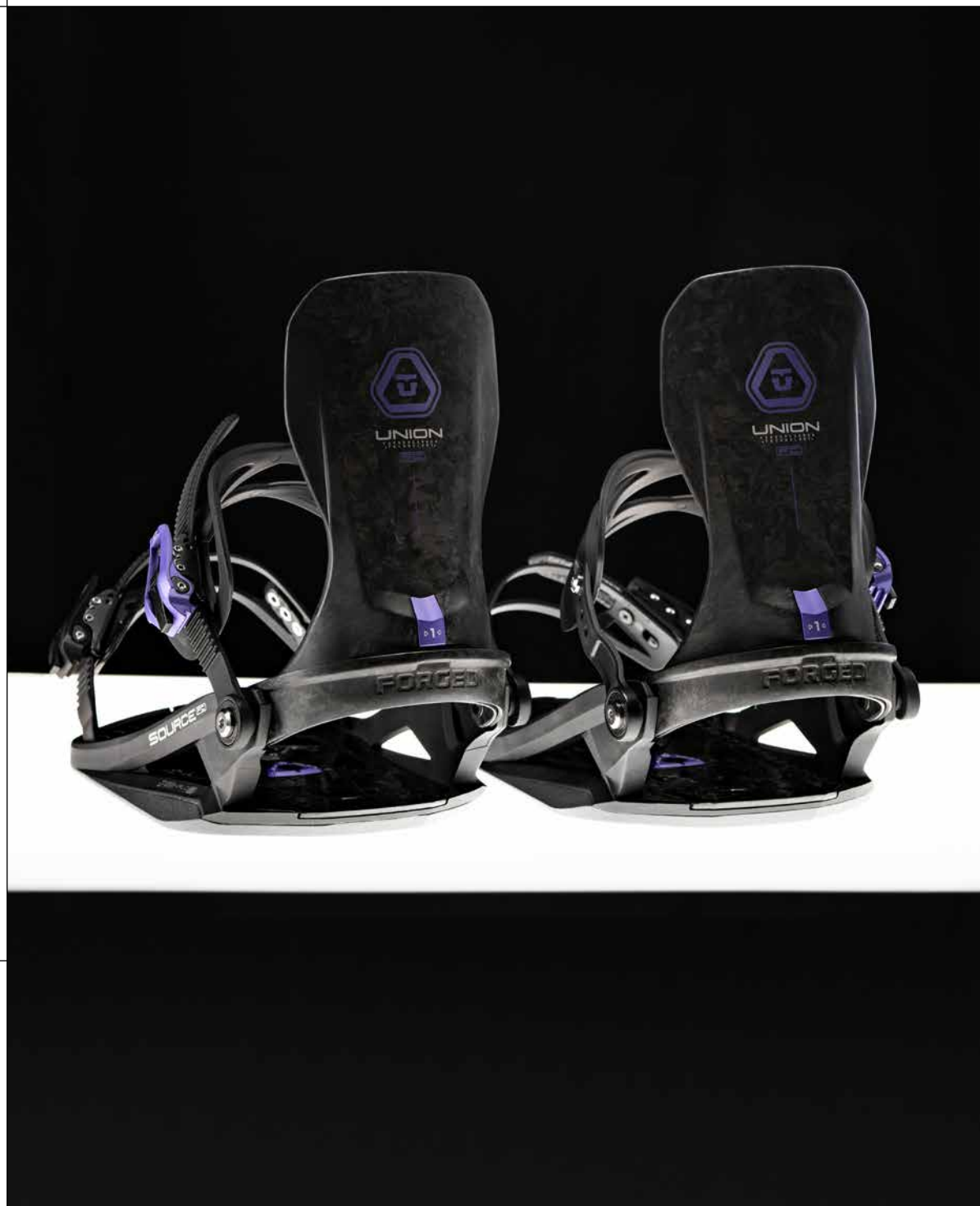

EPICENTER OF INNOVATION

The Union Lab is brought to life within our state-of-the-art research and development facility, The Box. This facility and this new category represent the pinnacle of scientific advancement and ingenuity. Equipped with the latest technology and materials, our team collaborates to push the boundaries of what's possible.



UNION
LAB

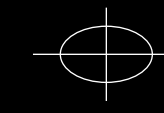
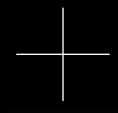

SOURCE FC



COLICO
46°08-09-N 9°22-18-E

COMING FALL 2025

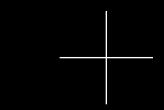
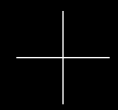

SOURCE FC

SOURCE FC

[01]

S18 SOURCE FORGED CARBON HIGHBACK

Extremely Lightweight + Responsive
Made In Italy

01

[02]

MAGNESIUM S1 RATCHETS

Reduced Ankle Ratchet Size
Lightweight + Durable

02

[03]

DIRECT CONNECT SYSTEM

Two Screws + Two Washers
No Disk

03

[04]

XB HALO BASEPLATE FRAME

Union's Lightest Baseplate Ever
+ Connection Point

04

05

[05]

PHANTOM SLIM ANKLE STRAP

25% Weight Reduction
Precision Fit

06

[06]

TS 6.0 TOE STRAP

Union's Lightest Toe Strap
Reduced Ratchet Base

[07]

FORGED CARBON DCS BASEPLATE COVER

Extremely Lightweight + Responsive
Instant Edge-To-Edge Connection
Reduced Height

07

[08]

HI-FLEX EVA BUSHING

Cushioning and Shock Absorption
Never Loses Shape

08



SOURCE FC → KEY FEATURES

①

① MOUNTING SYSTEM

DIRECT CONNECT SYSTEM

Union's all-new Direct Connect System is just that — a direct connection between you and your snowboard. By fully removing the disk from the baseplate, Union has been able to drastically improve the reaction speed between the rider and the snowboard, increase baseplate strength, and simultaneously reduce the overall weight of the binding. Disks are a thing of the past. This all-new mounting system only relies on two screws and two washers to get the job done.

[1.1]

STANCE ADJUSTMENT

-3° / +21°

1



[1.2]

MOUNTING COMPONENTS

Two Screws + Two Washers
Made from Grade 8.8 Steel and Aluminum

SOURCE FC → KEY FEATURES

②

BASEPLATE



TWO-LAYER BASEPLATE CONSTRUCTION

A traditional snowboard baseplate is made of a single layer with the same material and stiffness throughout. Union exclusive Two-Layer baseplate construction allows us to have two individual layers: the Core [1] and the Frame [2]. Each layer has the possibility of using a unique material and stiffness to achieve the desired ride feel of the binding.

FORGED CARBON DCS BASEPLATE CORE

The all-new Forged Carbon DCS Baseplate Core is stiff, responsive, and ultra-lightweight. Through extensive rounds of R&D the Union Lab was able to reduce the baseplate height by 10% getting you as close to the topsheet as possible. This baseplate layer allows for the fastest possible transfer of energy from the rider to the snowboard that Union has ever achieved. Made possible by Union exclusive Forged Carbon.



FC FORGED CARBON
UNION TECHNOLOGY SYSTEM-

XB HALO BASEPLATE FRAME

The XB Halo Base Frame is lightest baseplate Union has ever created, while still maintaining the mandatory strength-to-weight ratios needed to pass Union's strict durability tests. The frame also plays the critical role of connecting the baseplate core, bottom bushing, heelcup, ankle and toe straps together. Made with partially sustainable carbon injected Duraflex XB Nylon.

SOURCE FC → KEY FEATURES

③

③ BUSHING



HI-FLEX EVA BUSHING

More durable and more cushioned than traditional thermoformed EVA. Hi-Flex EVA bushings act as an additional layer of dampening and shock absorption between you and your snowboard and never lose shape over time. Your knees and feet will thank you. This all-new reduced volume bushing design allows the rider to be as close to the topsheet as possible.

④ HIGHBACK



S18 SOURCE FORGED CARBON HIGHBACK

The S18 Source Forged Carbon highback is 40% lighter than our standard nylon highbacks and extremely responsive edge-to-edge. Made in Italy using Union exclusive Forged Carbon.



⑤ HEELCUP



FORGED CARBON HEELCUP

Lightweight, responsive, and made in Italy. Union's Forged Carbon heelcups are 45% lighter than our standard Extruded Aluminum heelcups and still just as bombproof. Backed by Union's lifetime warranty guarantee.



SOURCE FC → KEY FEATURES

④

⑥ ANKLE STRAP



PHANTOM SLIM ANKLE STRAP

25% lighter than our standard Exoframe 4.0 Ankle Strap and still just as comfortable. The new Phantom Slim Ankle Strap features a smaller ratchet, smaller ladder, and a new streamlined lightweight ankle strap design to help reduce weight and materials as much as possible. You won't even notice that it's there.

⑦ TOE STRAP



TS 6.0 TOE STRAP

TS 6.0 toe straps keep you locked in for the ride down without letting you know they're there. A new, shorter buckle base helps to reduce weight and pressure points. Easily adjust to any boot with the quick turn of a lightweight titanium screw. This is the lightest toe strap on the market.

Source FC / Men's Snowboard Binding



Product Description

The connection between the rider and the snowboard has never been closer. We've removed the mounting disk, reduced the baseplate height, shaved off hundreds of grams of excess material and completely changed the way that the rider's energy is transferred from the body to the snowboard. The Union Source FC puts you in the driver's seat, are you ready for the ride?

Weight: 540 grams *(1/2 pair, Size M)

Binding Performance

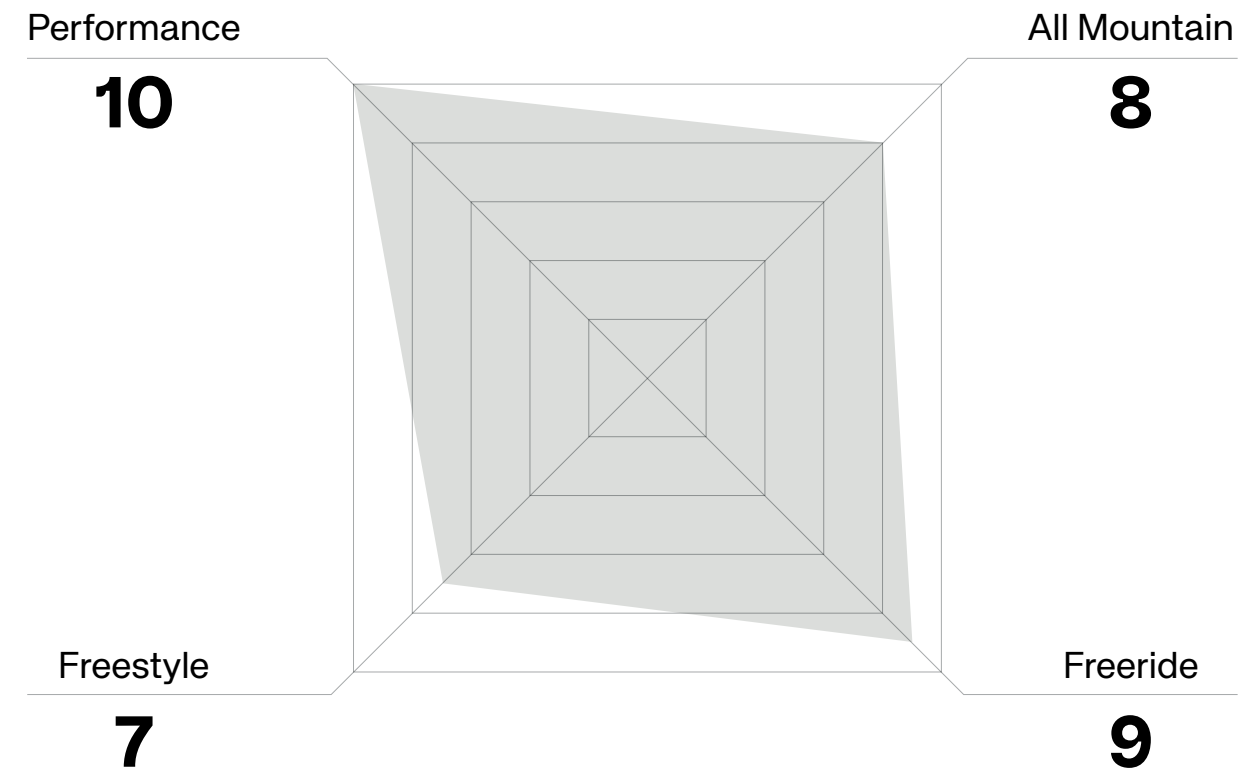

Binding Flex Edge-to-Edge: 9/10



Binding Flex Side-to-Side: 7/10



Key Features

Lightest Snowboard Binding Ever Developed

All-New Direct Connect System

Reduced Baseplate Height

Italian Made Forged Carbon

Technology

Technology	New
BASEPLATE: S10 Halo Duraflex XB	●
BUSHING: Hi-Flex HP EVA	●
GAS PEDAL: Forged Carbon	●
CANTING: No	●
HIGHBACK: S18 Source FC	●
FLAD: Integrated 3-Stage	●
HEELCUP: Forged Carbon	●
ANKLE STRAP: Phantom Slim	●
TOE STRAP: TS 6.0	●
STRAP ADJUST: Titanium Screws	●
RATCHETS: Magnesium S1 w/Aluminum Base	●
HARDWARE: Grade 8.8 Steel + Titanium	●

Compatibility:

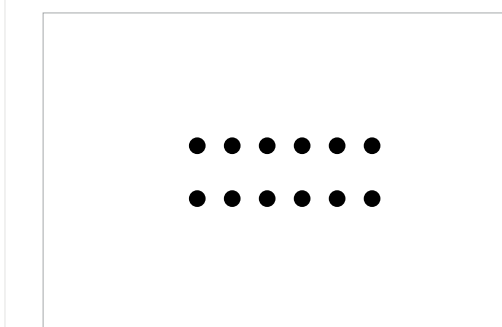

4x2

Disk:



Direct Connect System





01.

Color: **Black**
Size: **M, L**



Angle: Back 3/4

Source FC

Colorways: 01 ●

Source Pro / Men's Snowboard Binding



Product Description

Engineered for precision, the Union Source Pro delivers a balanced ride for snowboarders who seek performance without the extreme feeling of the Source FC. With a slightly less aggressive highback and wider ankle straps, it offers exceptional comfort and control while maintaining the closest connection possible between the rider and snowboard.

Weight: 700 grams *(½ pair, Size M)

Binding Performance

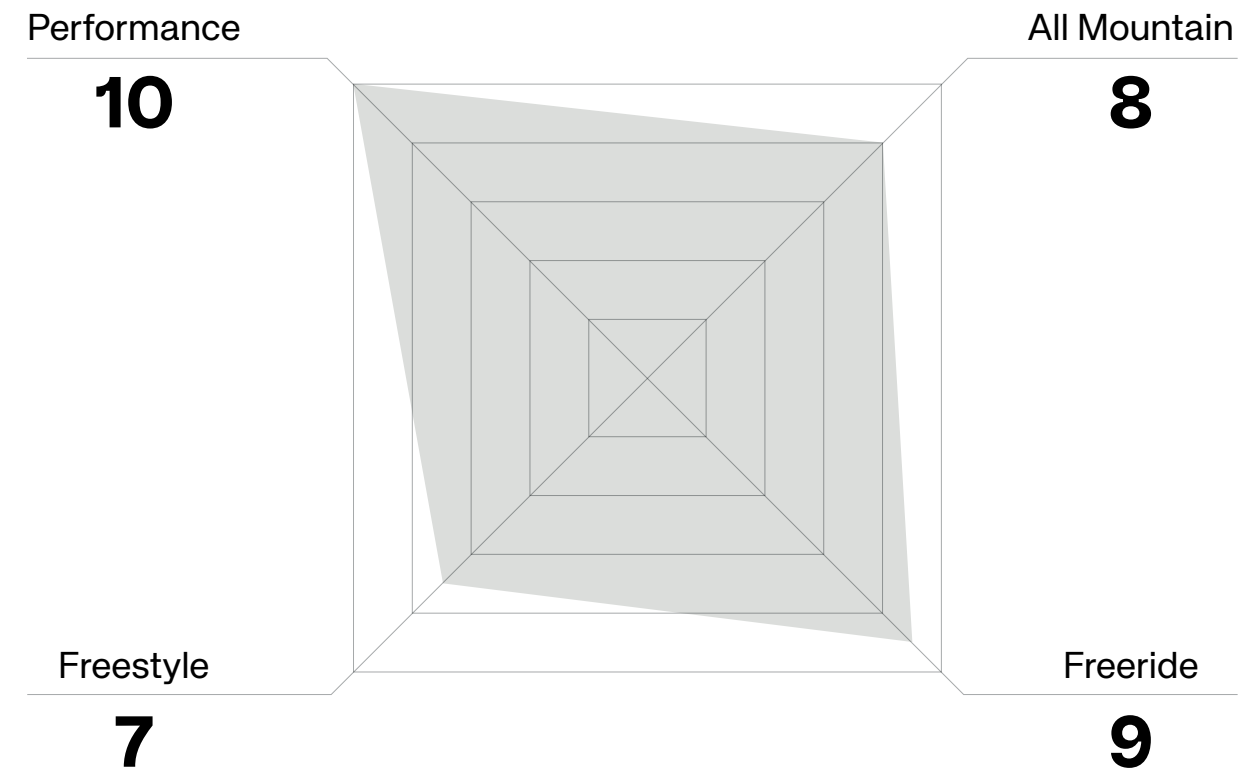

Binding Flex Edge-to-Edge: 9/10



Binding Flex Side-to-Side: 7/10



Key Features

- All-New Direct Connect System
- Reduced Baseplate Height
- Italian Made Forged Carbon
- Ridden By: Torstein Horgmo

Technology

Technology	New
BASEPLATE: S10 Halo Duraflex CB	●
BUSHING: Hi-Flex HP EVA	●
GAS PEDAL: Forged Carbon	●
CANTING: No	●
HIGHBACK: S18 Source Pro	●
FLAD: Integrated 3-Stage	●
HEELCUP: Extruded 3D Aluminum	●
ANKLE STRAP: Hybrid 2.0	●
TOE STRAP: TS 6.0	●
STRAP ADJUST: Pin	●
RATCHETS: Magnesium S1 w/Aluminum Base	●
HARDWARE: Grade 8.8 Steel + Titanium	●

Compatibility:

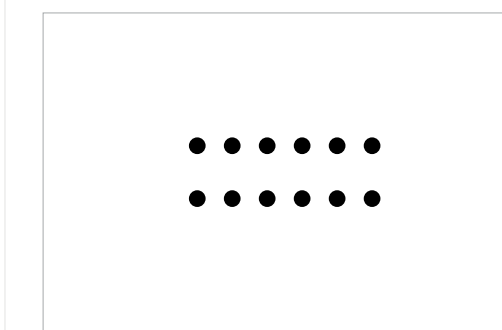

4x2

Disk:



Direct Connect System





01.

Color: **Black**
Size: **M, L**



Angle: Back 3/4

Source Pro

Colorways: 01 ●



UNION

STEP ON®

©

25.26



Step ON®

UBC

CORE SRL®
46°08-09-N 9°22-18-E
Via Colombano, 10
23014 Delebio SO, Italy

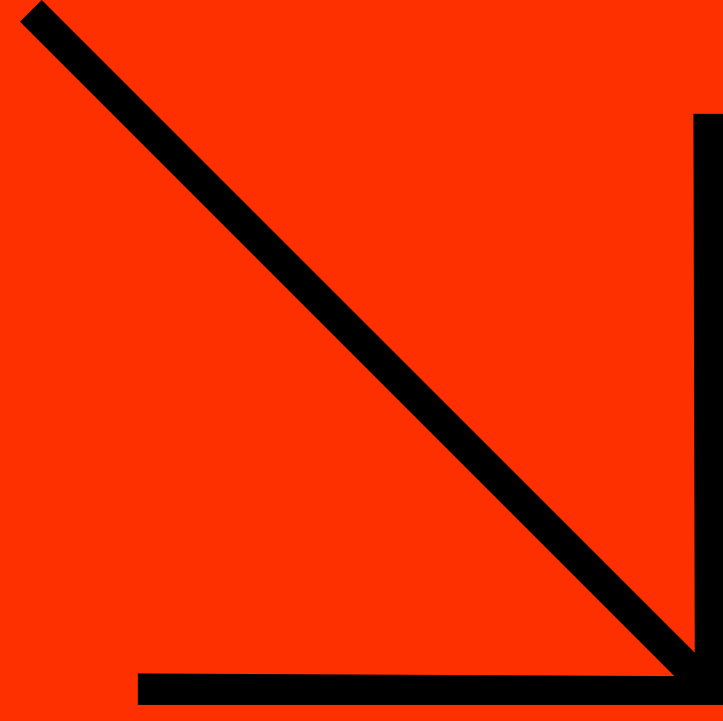

CREATING AN INDUSTRY STANDARD



BRANDS WORKING TOGETHER FOR SNOWBOARDING

You've been asking, and we've been listening. We're excited to announce a partnership with Burton as we expand our line to offer a mechanical entry binding system. Together with Burton, we believe that there is an opportunity to come together as industry leaders to support snowboarding.

Like Burton, we are selective in our projects and our partners. Step On® is the right technology to bring our product offering to the next level, and Burton is the partner to do it. This partnership is the result of our shared commitment to establishing an industry-standard mechanical entry system for the wider binding ecosystem.

Starting in 2025, Union is 100% committed to the Step On® category.



ATLAS

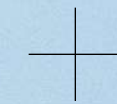
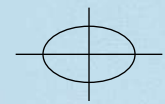

 | **Step ON**[®]

COLICO
46°08-09-N 9°22-18-E

COMING JANUARY 2025



ATLAS



[01]

ATLAS STEP ON® DURAFLEX HIGHBACK

Asymmetrical Design
+ Adjustable Forward Lean

01

05

[05]

INTEGRATED 2-STAGE FLAD

Adjustable Forward Lean
Relative Angle: Standard / +5°

[02]

STEP ON® INSTANT CONNECTION™ SYSTEM

Fast In, Fast Out
Innovative Boot-To-Binding Connection Point

02

[06]

NON-STICK HP EVA DISK COVER

Closed Cell Finish
100% Ice & Waterproof

06

[03]

EXTRUDED 3D ALUMINUM HEELCUP

Durable + Lightweight
Lifetime Warranty Guarantee

03

[07]

STEP ON® INSTANT CONNECTION™ SYSTEM

Fast In, Fast Out
Innovative Boot-To-Binding Connection Point

07

[04]

ATLAS STEP ON® BASEPLATE

Unmatched Durability
Lifetime Warranty Guarantee

04

[08]

HI-FLEX EVA BUSHING

Dampening + Shock Absorption
Unique to Union Step On® Bindings

08



ATLAS STEP ON® → KEY FEATURES



1 CONNECTION SYSTEM

STEP ON® INSTANT CONNECTION™ SYSTEM

Fast in, fast out. The Step On® Instant Connection™ System is the only automatic binding system that meets Union's standards of performance, durability, comfort, and function. Simply step into the binding heel-first to engage the heel clip, then press down on your toes until you hear the clicks. When it's time to get out, pull the lever on the heel of the binding and twist your foot. It's that easy.



[1.1]

HEEL CLIP

Step into the binding heel-first.
Engage the heel clip.

1

[1.3]

RELEASE LEVER

To exit, pull the release lever and twist your foot.

3

[1.2]

TOE CLIPS

Press down on your toes until you
hear the clicks of the toe clips.

2



ATLAS STEP ON® → KEY FEATURES

②

① BASEPLATE



ATLAS STEP ON® BASEPLATE

Union strength and dependability + the easy-to-use performance of the Step On® Instant Connection™ System. The engineering team at Union has spent countless hours perfecting the all-new Atlas Step On® Baseplate. Backed by Union's lifetime warranty guarantee.

② BUSHING



HI-FLEX EVA BUSHING

Hi-Flex EVA bushings act as an additional layer of dampening and shock absorption between you and your snowboard and never lose shape over time. Your knees and feet will thank you.

ATLAS STEP ON® → KEY FEATURES

③

④ DISK COVER



NON-STICK HP EVA DISK COVER

The next evolution of Union's non-stick EVA technology. Non-Stick Hot Press EVA creates a closed cell finish that's 100% waterproof. Gone are the days of snow and ice buildup on your bindings. Easily adjusts for the perfect fit with your boots.

⑤ HIGHBACK



ATLAS STEP ON® DURAFLEX HIGHBACK

The all-new Atlas Step On® Duraflex highback combines legendary Union Atlas performance with the easy-to-use Step On® Instant Connection™ System. Equipped with two stages of forward lean, you can easily dial in the highback to suit your preferred riding style.

Atlas Step On® / Men's Snowboard Binding



Product Description

Fast in, fast out. The all-new Union Atlas featuring Step On® Instant Connection™ System combines proven Step On® technology with innovative Union design. The Atlas Step On® snowboard binding is your key to quick and easy precision performance on the mountain.

Weight: 750 grams *(½ pair, Size M)

Binding Performance

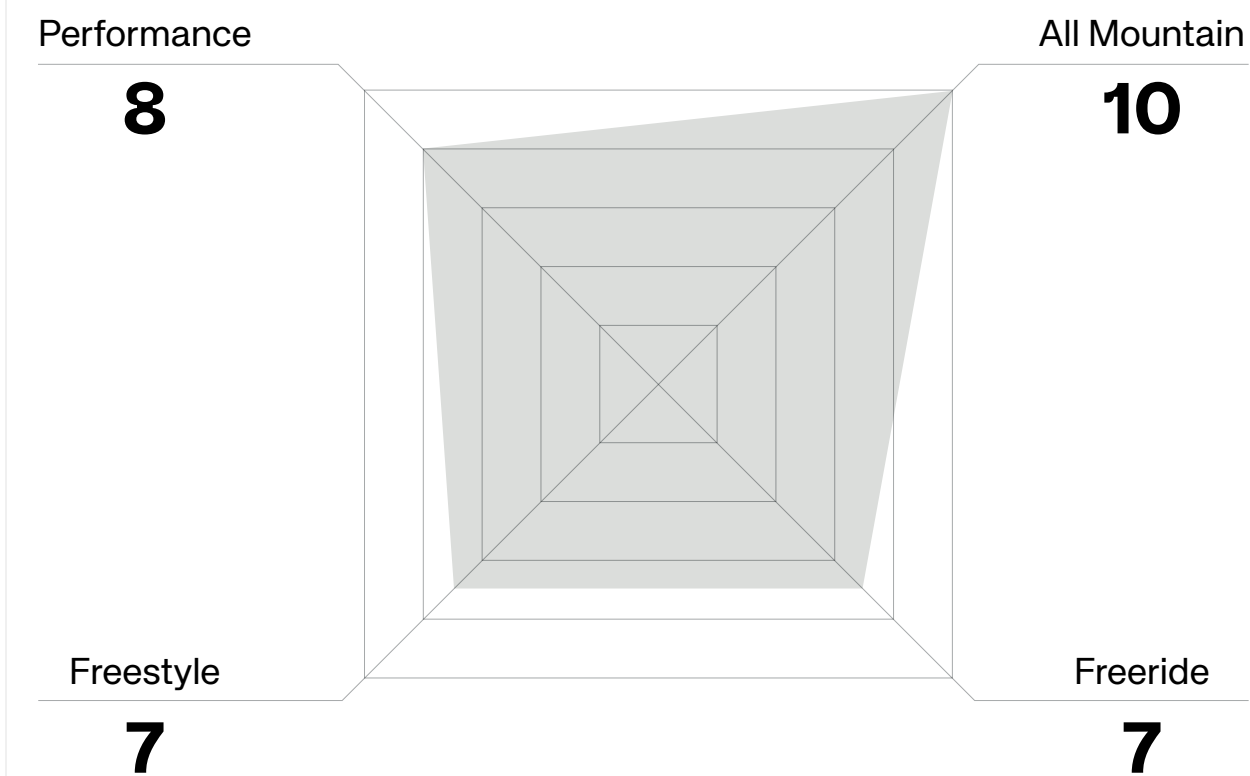

Binding Flex: 8/10



Compatibility:

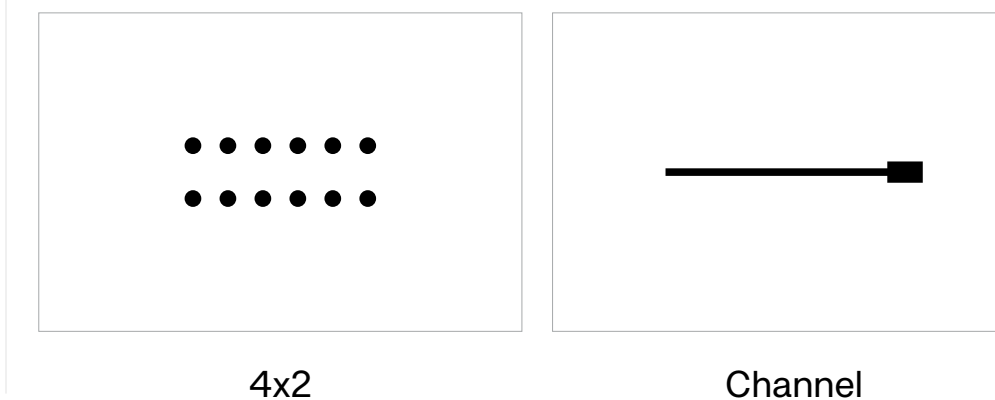

Key Features

- Step On® Instant Connection™ System
- Adjustable Forward Lean
- Adjustable Gas Pedal
- Hi-Flex EVA Bushing

Technology

Technology	Specification	New
BASEPLATE:	Atlas Step On® Duraflex CB	●
BUSHING:	Hi-Flex HP EVA	●
DISK COVER:	Non-Stick HP EVA	●
CANTING:	No	●
HIGHBACK:	Atlas Step On® Duraflex CB	●
FLAD:	Integrated 2-Stage	●
HEELCUP:	Extruded 3D Aluminum	●
HARDWARE:	Grade 8.8 Steel	●
CONNECTION SYSTEM:	Step On®	●

Step ON®

Union Binding Company is the only licensing partner developing and producing its own products, which feature the Step On® Instant Connection™ System.

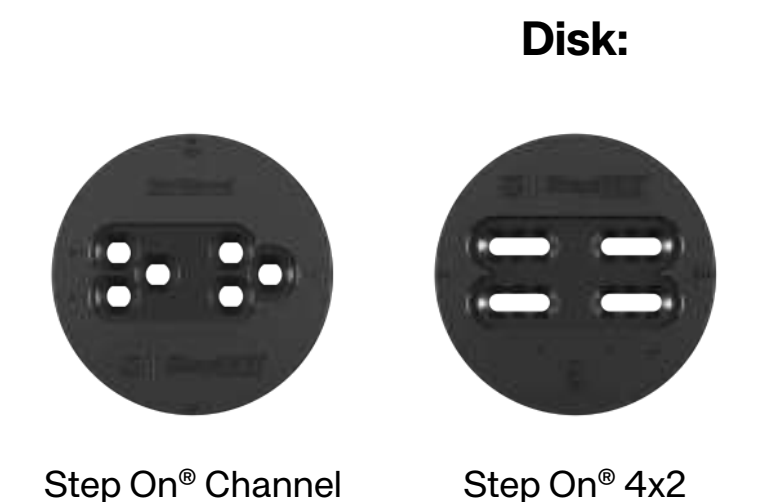



01.

Color: **Black**
Size: **S, M, L, XL**



02.

Color: **White**
Size: **S, M, L, XL**



03.

Color: **Orange**
Size: **S, M, L, XL**



04.

Color: **White/Orange** ✂ EARLY RELEASE
Size: **S, M, L, XL**



Angle: Back 3/4

Atlas Step On®

Colorways: 04 ● ○ ● ○



UNION | **Step ON**®



UNION BINDING

COMPANY

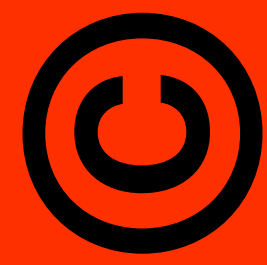

25.26



UBC

CORE SRL®
46°08-09-N 9°22-18-E
Via Colombano, 10
23014 Delebio SO, Italy

STRONGER.

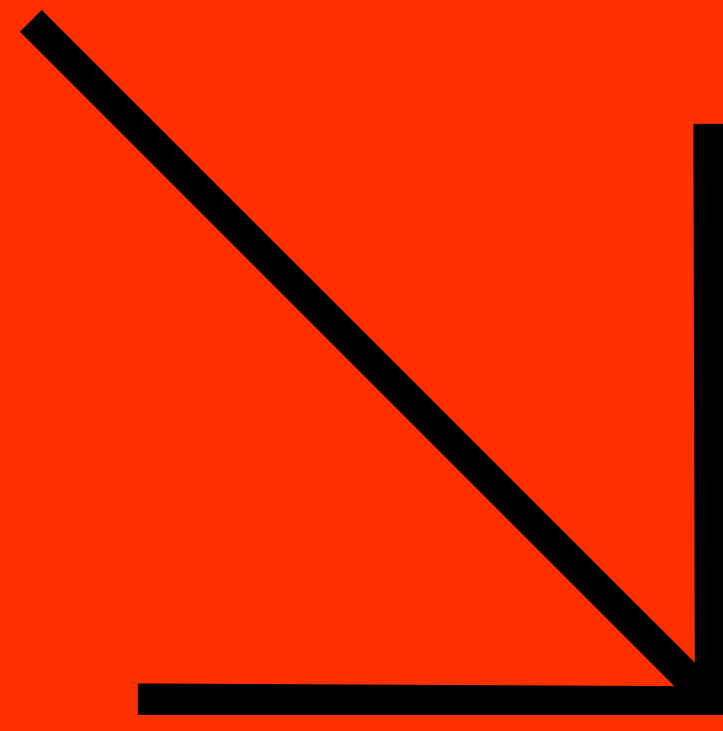

UNION BINDING COMPANY ↔

The goals at Union are simple: continue to be a leader in clean energy, engage in social responsibility at a local level, and constantly develop cutting-edge technology and manufacturing techniques.

With three full production years under our belt, The Box has proven its investment return, setting new standards on quality and timely delivery. In a nutshell, we have increased production efficiency, contributed to our community, drastically reduced energy consumption in production, and passed these overall values to our customers.

Union is more than just a product to enhance your snowboard experience—it's a philosophy and way of life.

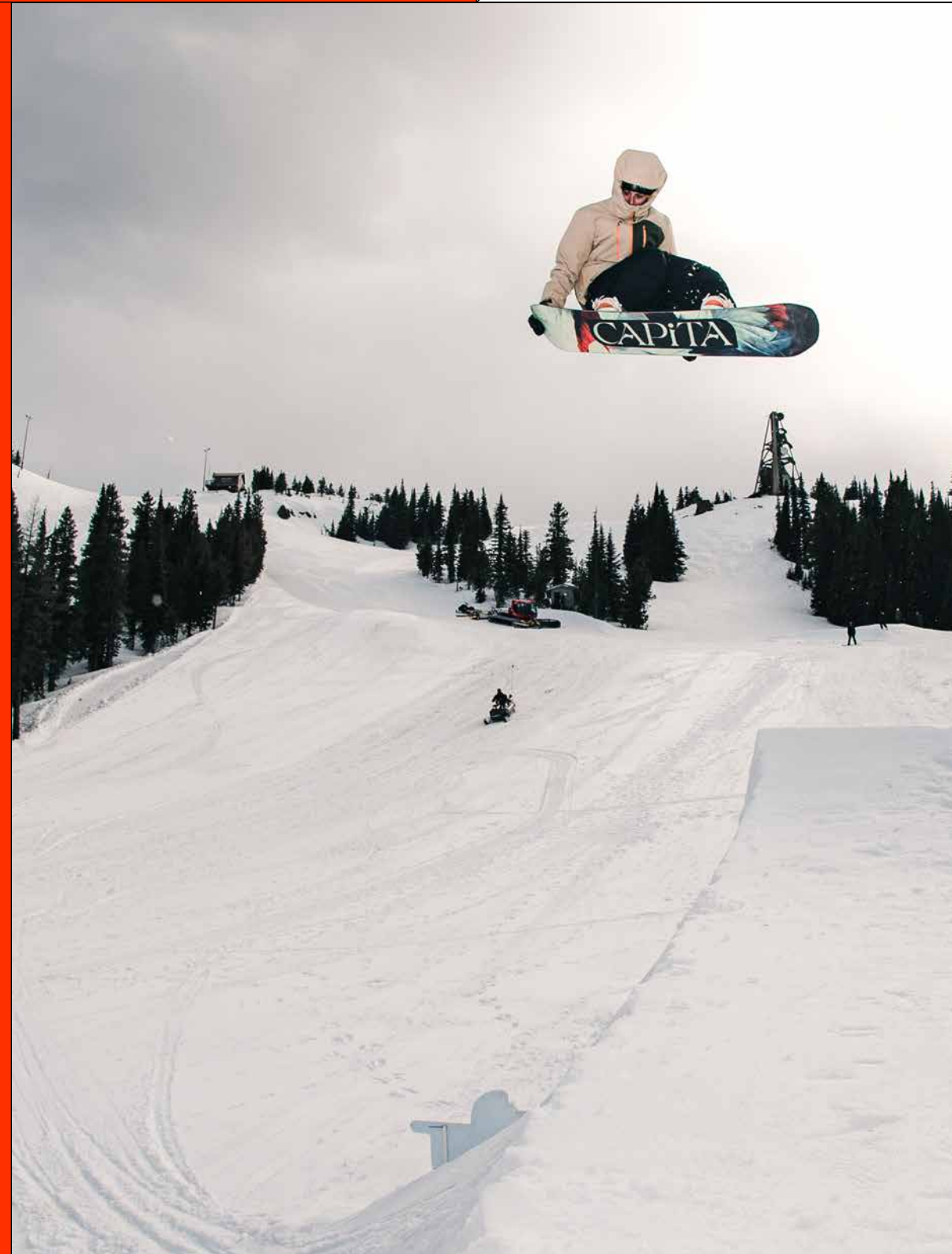

Our Mission ↘

Dedicated to manufacturing the best snowboard bindings on the planet.

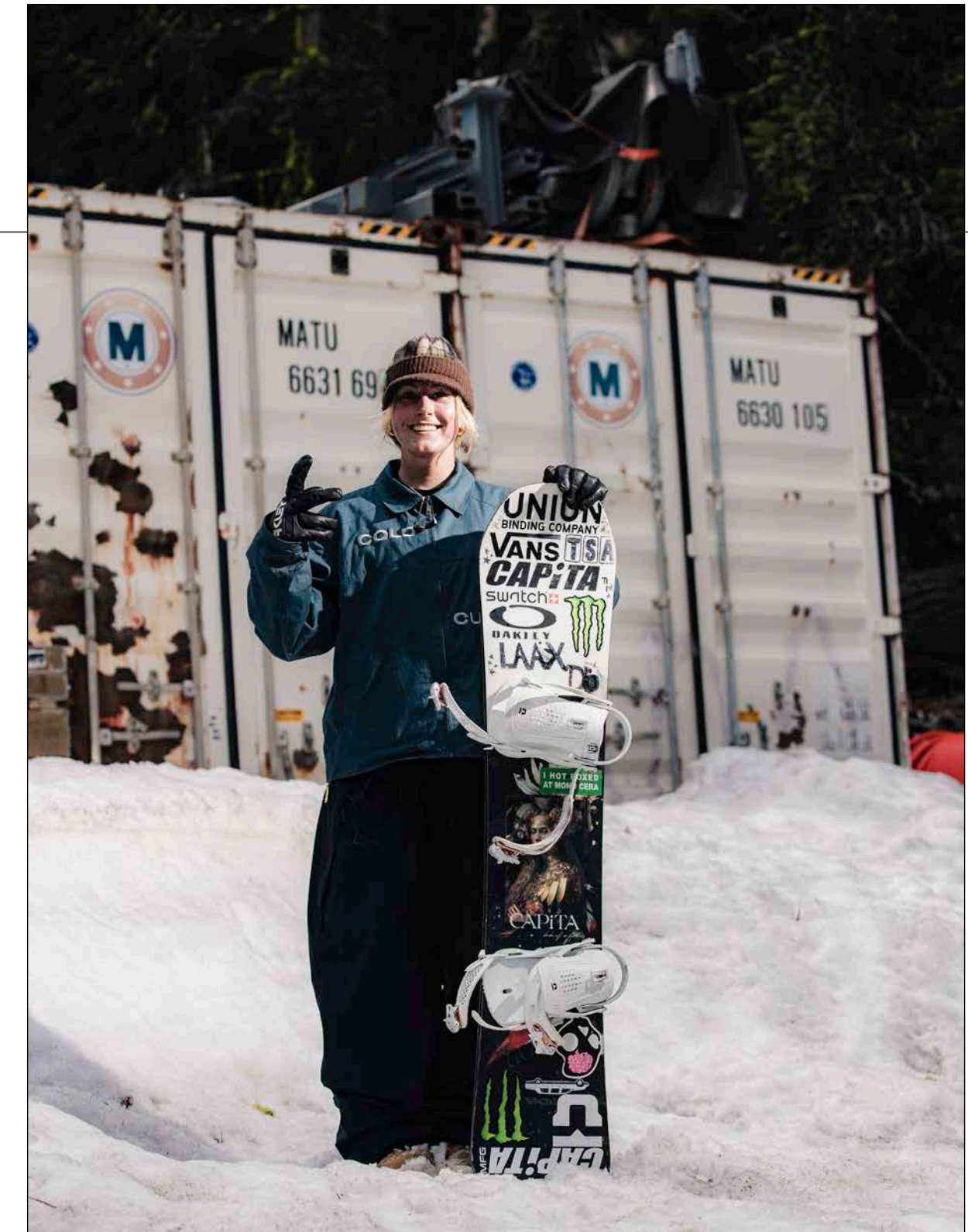

 Union Binding Company
© Core SRL

Rider: Mia Brookes | Photo: Matt Roebke 



DESIGNED, TESTED, AND ENGINEERED IN THE ITALIAN ALPS

THE BOX™

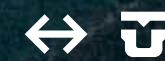

Union's global headquarters is located a quick 45 minute drive from the closest chairlift. Living and working in the heart of the Italian Alps gives us the opportunity to test in the morning, be back in the office by lunch, adjust and modify designs by the end of the day.

- Solar + Hydro Powered
- In-house Design & Engineering
- Testing and R&D
- 3D Advanced Prototype Lab
- Forged Carbon Production
- Manufacturing
- Assembly
- Logistics

UBC: Colico, Italy

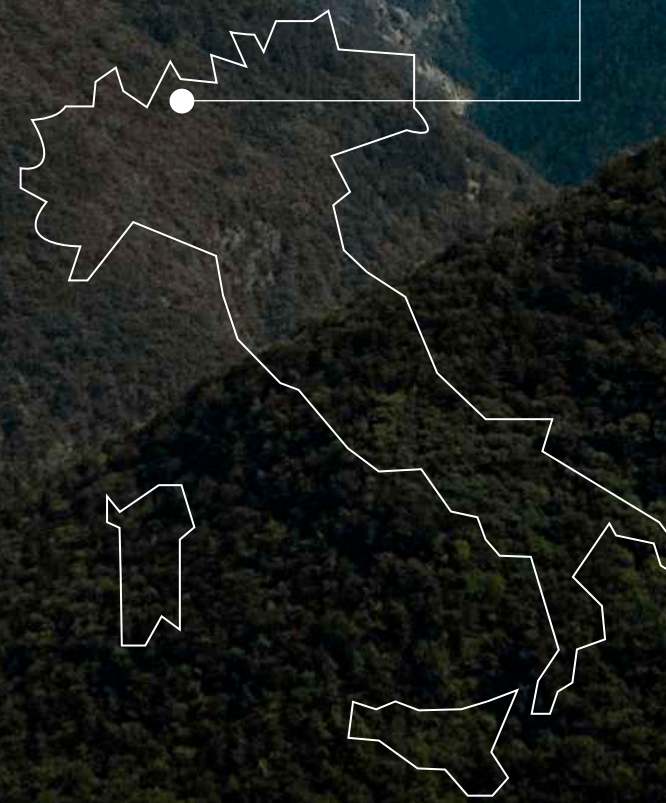

2

GLOBAL BINDING FACTORIES

100%

CONTROL OF THE PROCESS

00:45m

TO NEAREST CHAIRLIFT



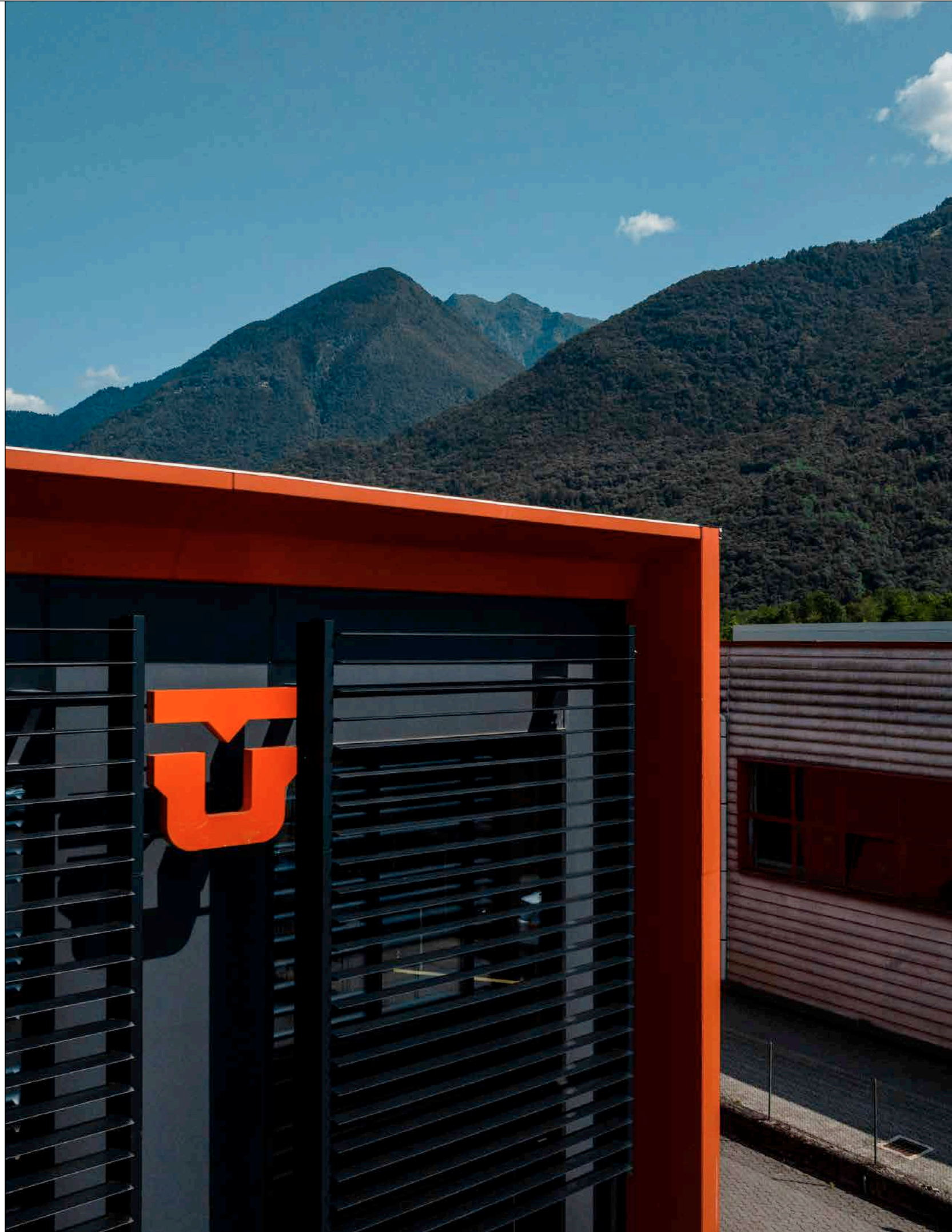

COLICO:ITALY
46°08—09—N 9°22—18—E
STRONGER™



UBC—MFG

Open 24 Hours

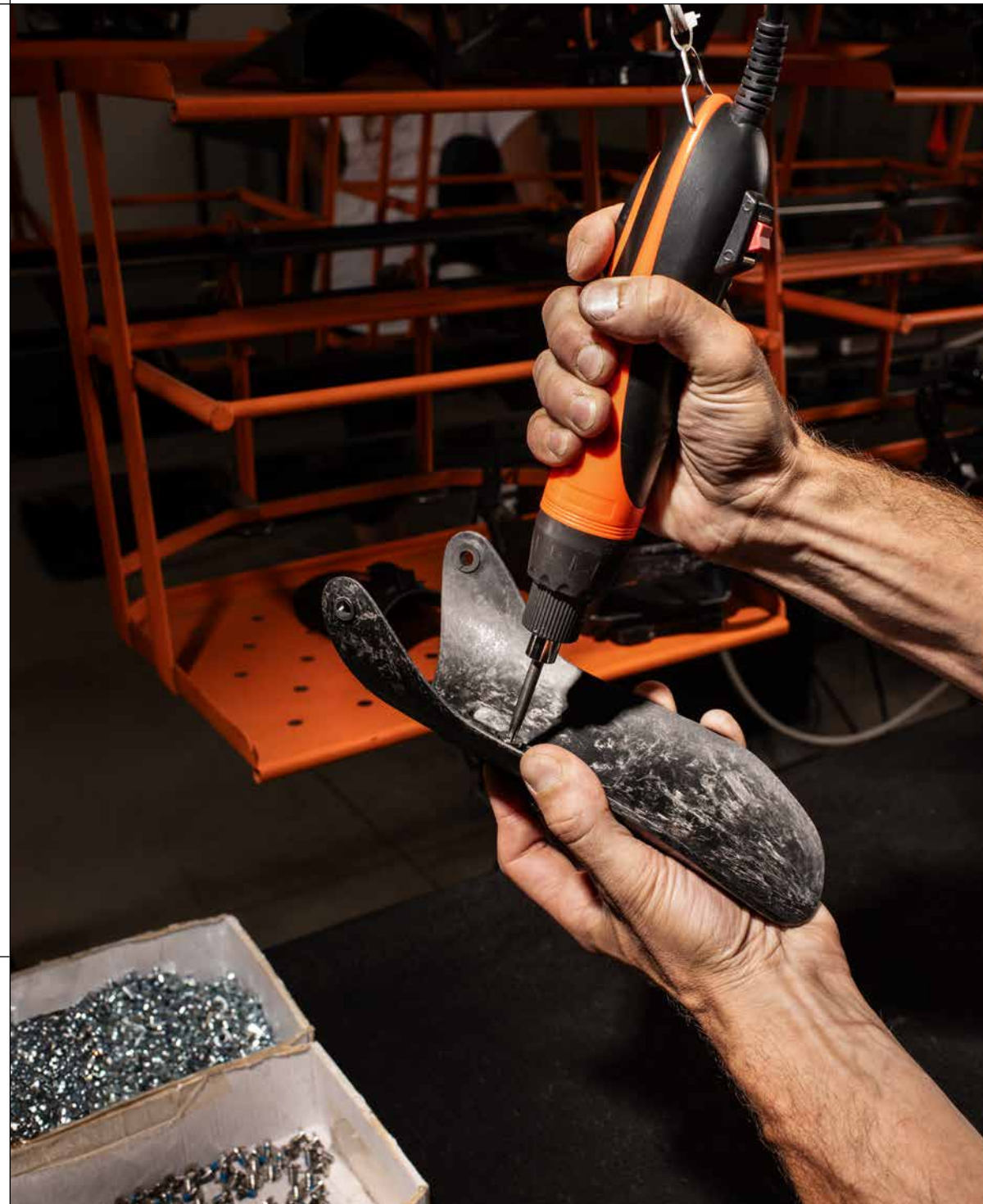
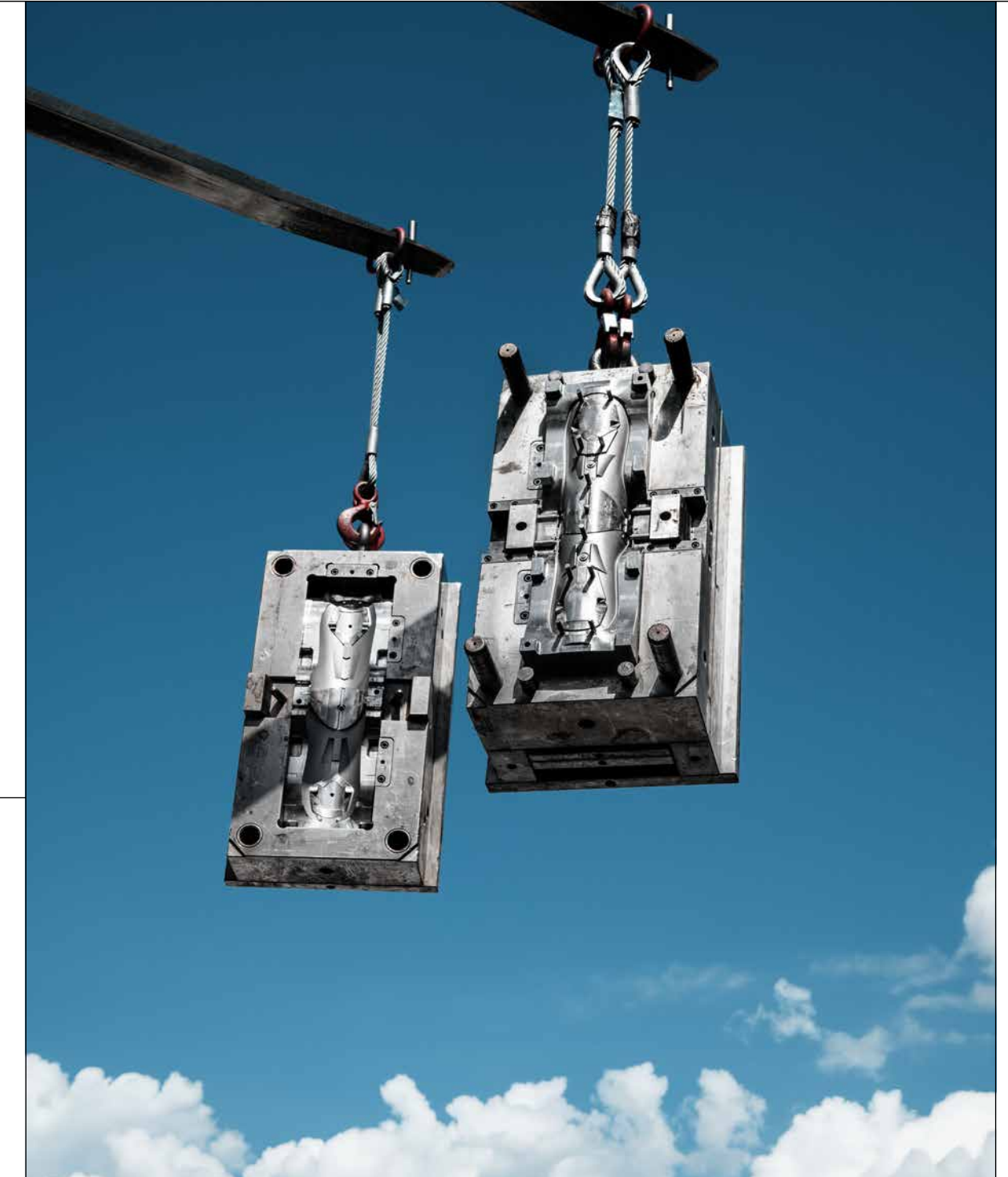

WE MAKE OUR OWN BINDINGS

Union is the only conventional binding supplier who owns and operates its own production facilities. A dedicated collective of binding designers, production experts and passionate snowboarders.

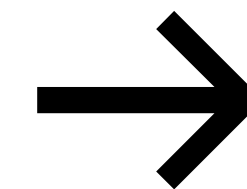
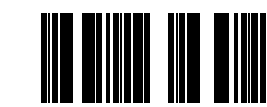

TRUSTED BY PROFESSIONALS

THE UNION TEAM



From the streets, to the Olympics, to the top of Alaska's biggest spines. Union's global team of over 100 professional athletes is a testament to the quality and performance of our product. There's a reason why more professional snowboarders trust Union Binding Company than any other brand on the market today.

TEAM



100+

GLOBAL ATHLETES

85

AVERAGE DAYS ON SNOW PER SEASON

93.6K

HOURS SPENT PRODUCT TESTING PER YEAR

Rider: Miles Fallon | Photo: Jack Dawe



PERFORMANCE

TECHNICAL

RESPONSIVE

HARD CHARGING

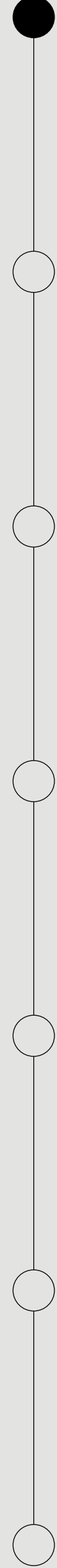
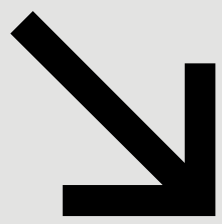
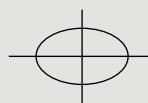

Rider: Travis Rice | Photo: Chad Chomlack



Falcor / Unisex Snowboard Binding

TRAVIS RICE
PRO MODEL



Product Description

The latest generation of the Travis Rice Falcor raises the bar for snowboard binding design and utilizes the best materials that Union Binding Company has to offer. This high-performance freeride/freestyle snowboarding binding is designed specifically for Travis' aggressive riding style and is ready to take on the biggest lines and the steepest spines in snowboarding.

Weight: 855 grams

Binding Performance

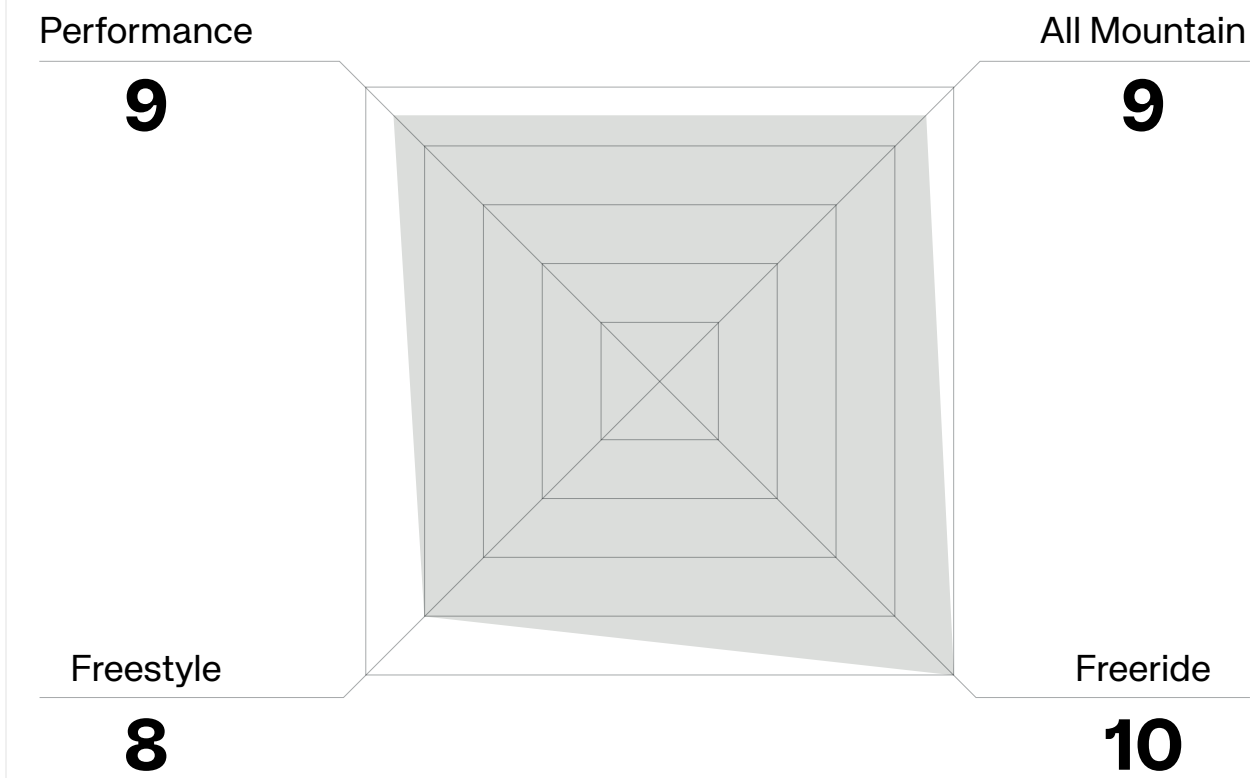

Binding Flex: 7/10

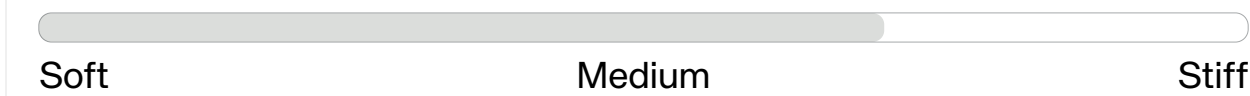

Compatibility:

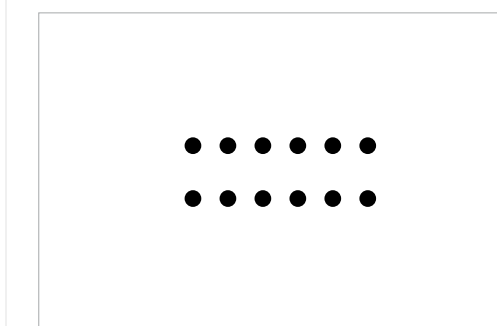

4x2

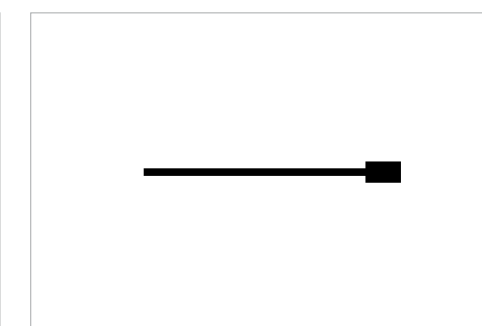

Channel

Disk:

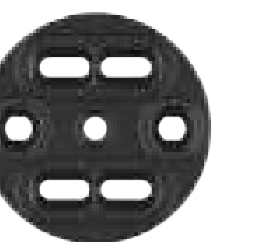

Mini Disk

Key Features

Italian Made Forged Carbon

Sustainable Materials

Marketed Model

Ridden By: Travis Rice

Technology

New

- BASEPLATE: S12 Duraflex Blue
- BUSHING: Asym Molecular Bushing
- DISK COVER: Non-Stick EVA
- CANTING: Yes
- HIGHBACK: S20 Asym Forged Hybrid 3.0
- FLAD: Classic
- HEELCUP: Extruded 3D Aluminum
- ANKLE STRAP: Hybrid 1.0
- TOE STRAP: TS 6.0
- STRAP ADJUST: Tool-Less 3.0
- RATCHETS: Magnesium S1 w/Aluminum Base
- HARDWARE: Grade 8.8 Steel





01.

Color: **Black**
Size: **S, M, L**



02.

Color: **Fossil Grey**
Size: **S, M, L**



03.

Color: **Haze**
Size: **S, M, L**

✕ Marketed Colorway



Angle: Back 3/4

Falcor

Colorways: 03 ● ● ○



Atlas Pro / Unisex Snowboard Binding



Product Description

Discover the benefits of instant edge-to-edge response with the Union Atlas Pro. The Atlas Pro is a high performance snowboard binding for intermediate to advanced snowboarders looking to push their riding to the limits. The combination of Italian made Forged Carbon and Duraflex CB nylon provides a stiff and responsive ride feel that adds a new level of power and control to your snowboarding.

Key Features

- Italian Made Forged Carbon
- New Bushing Material
- Marketed Model
- Ridden By: Kazu Kokubo

Weight: 930 grams

Binding Performance

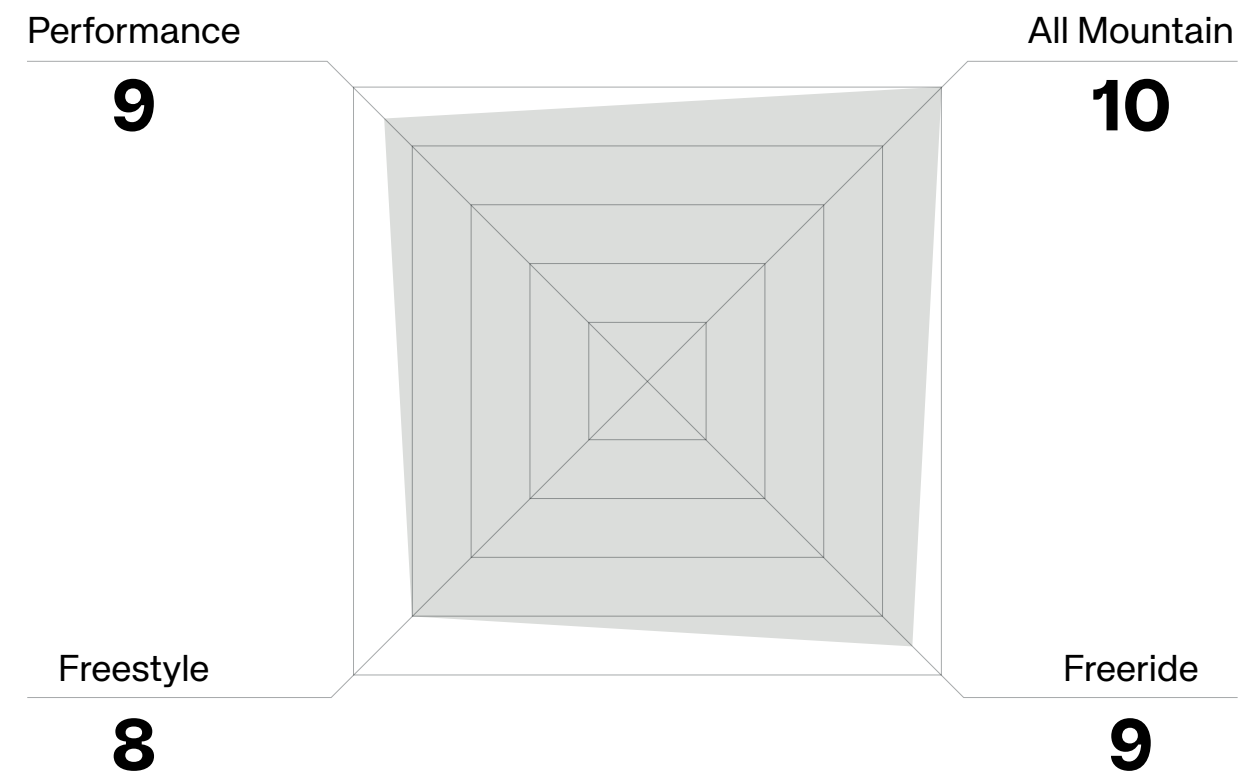

Binding Flex: 8.5/10



Compatibility:

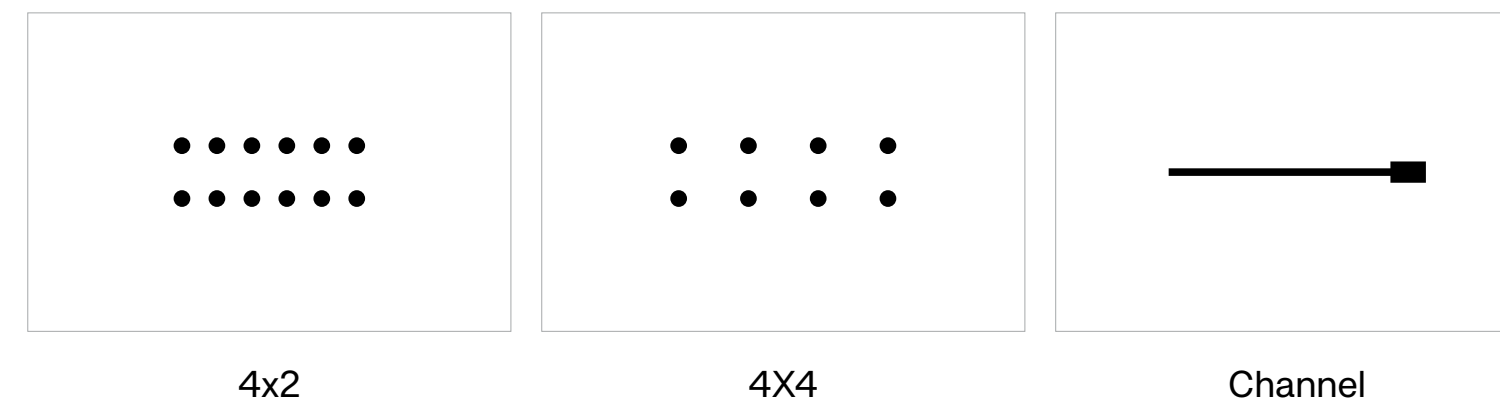

Disk:



Camber Disk + Dual Washer

Technology

Technology	Value	New
BASEPLATE:	S7 Duraflex CB	<input type="radio"/>
BUSHING:	Vaporlite HD 2.0	<input checked="" type="radio"/>
DISK COVER:	Forged Carbon w/Non-Stick EVA	<input type="radio"/>
CANTING:	Yes	<input type="radio"/>
HIGHBACK:	S14 Duraflex CB	<input type="radio"/>
FLAD:	Integrated	<input type="radio"/>
HEELCUP:	Extruded 3D Aluminum	<input type="radio"/>
ANKLE STRAP:	Hybrid 2.0	<input type="radio"/>
TOE STRAP:	TS 6.0	<input type="radio"/>
STRAP ADJUST:	Tool-Less 3.0	<input checked="" type="radio"/>
RATCHETS:	Magnesium S1 w/Aluminum Base	<input type="radio"/>
HARDWARE:	Grade 8.8 Steel	<input type="radio"/>





01.
Color: **Metallic Black**
Size: **S, M, L**



02.
Color: **Metallic White**
Size: **S, M, L**



03.
Color: **Kazu Kokubo** X Marketed Colorway
Size: **S, M, L**



Angle: Back 3/4

Atlas Pro

Colorways: 03 ● ○ ●



ATLAS PRO KAZU KOKUBO

Kazu Kokubo

UNION BINDING COMPANY
STRONGER.



HIGH PERFORMANCE EDGE-TO-EDGE POWER COMBINED WITH THE UNMATCHED STYLE OF KAZU KOKUBO. PUSH YOUR RIDING TO THE LIMITS.

UNION PERFORMANCE

Atlas / Unisex Snowboard Binding



Product Description

The go-to all mountain binding for intermediate to advanced snowboarders looking to charge hard in all conditions. The Union Atlas is a medium to stiff flexing snowboard binding that provides powerful edge to edge response around the resort and in the backcountry. Designed, tested and trusted by the best snowboarders in the world.

Key Features

- Unisex Design
- Marketed Model
- Bombproof Construction
- Ridden By: Kevin Backstrom

Weight: 920 grams

Binding Performance

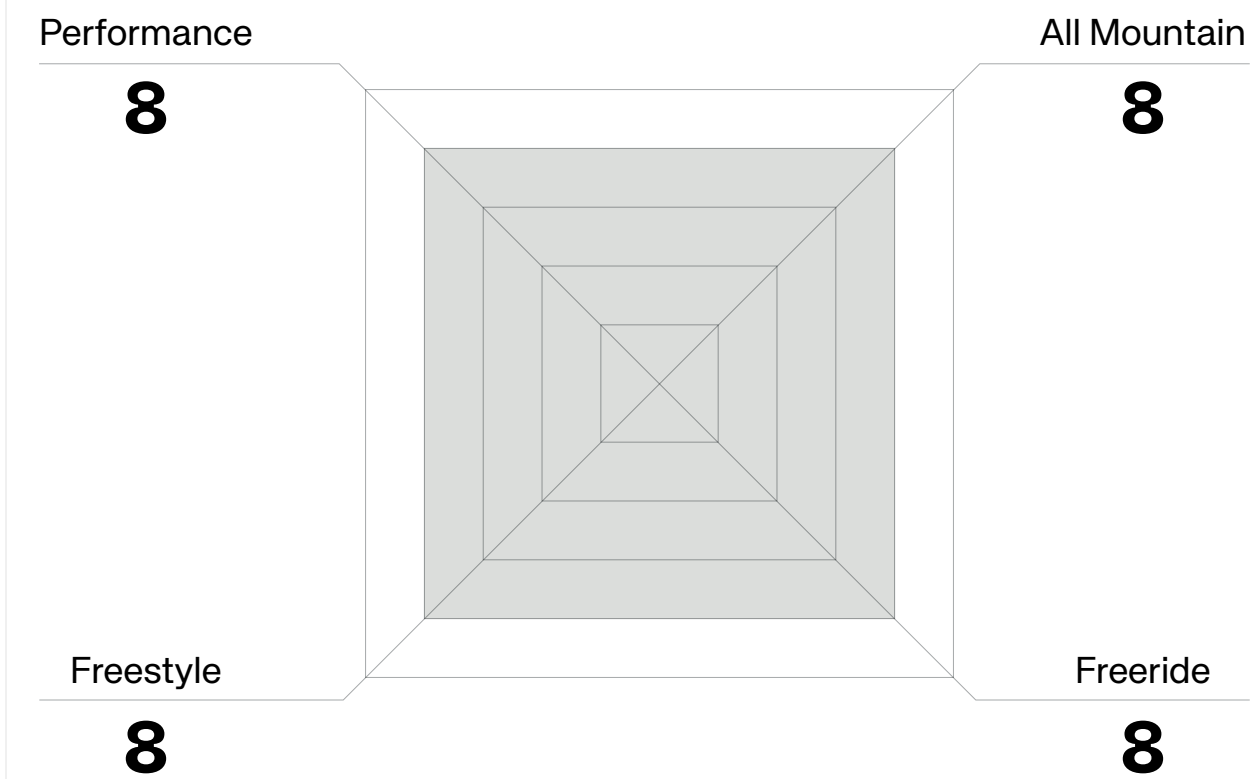

Binding Flex: 8/10



Compatibility:

4x2

4x4

Channel

Disk:



Camber Disk + Dual Washer

Technology

Technology	Value	New
BASEPLATE:	S7 Duraflex CB	<input type="checkbox"/>
BUSHING:	Vaporlite HD 2.0	<input checked="" type="checkbox"/>
DISK COVER:	Non-Stick EVA	<input type="checkbox"/>
CANTING:	Yes	<input type="checkbox"/>
HIGHBACK:	S22 Duraflex CB	<input type="checkbox"/>
FLAD:	Tool-Less	<input type="checkbox"/>
HEELCUP:	Extruded 3D Aluminum	<input type="checkbox"/>
ANKLE STRAP:	Exoframe 5.0	<input type="checkbox"/>
TOE STRAP:	TS 6.0	<input type="checkbox"/>
STRAP ADJUST:	Tool-Less 3.0	<input checked="" type="checkbox"/>
RATCHETS:	Magnesium S1 w/Steel Base	<input type="checkbox"/>
HARDWARE:	Grade 8.8 Steel	<input type="checkbox"/>





01.

Color: **Black**
Size: **S, M, L**



02.

Color: **Hype Yellow** **X Marketed Colorway**
Size: **S, M, L**



03.

Color: **Violet**
Size: **S, M, L**



04.

Color: **White/Orange**
Size: **S, M, L**



Angle: Back 3/4

Atlas

Colorways: 04 ● ● ● ●



Performance Overview

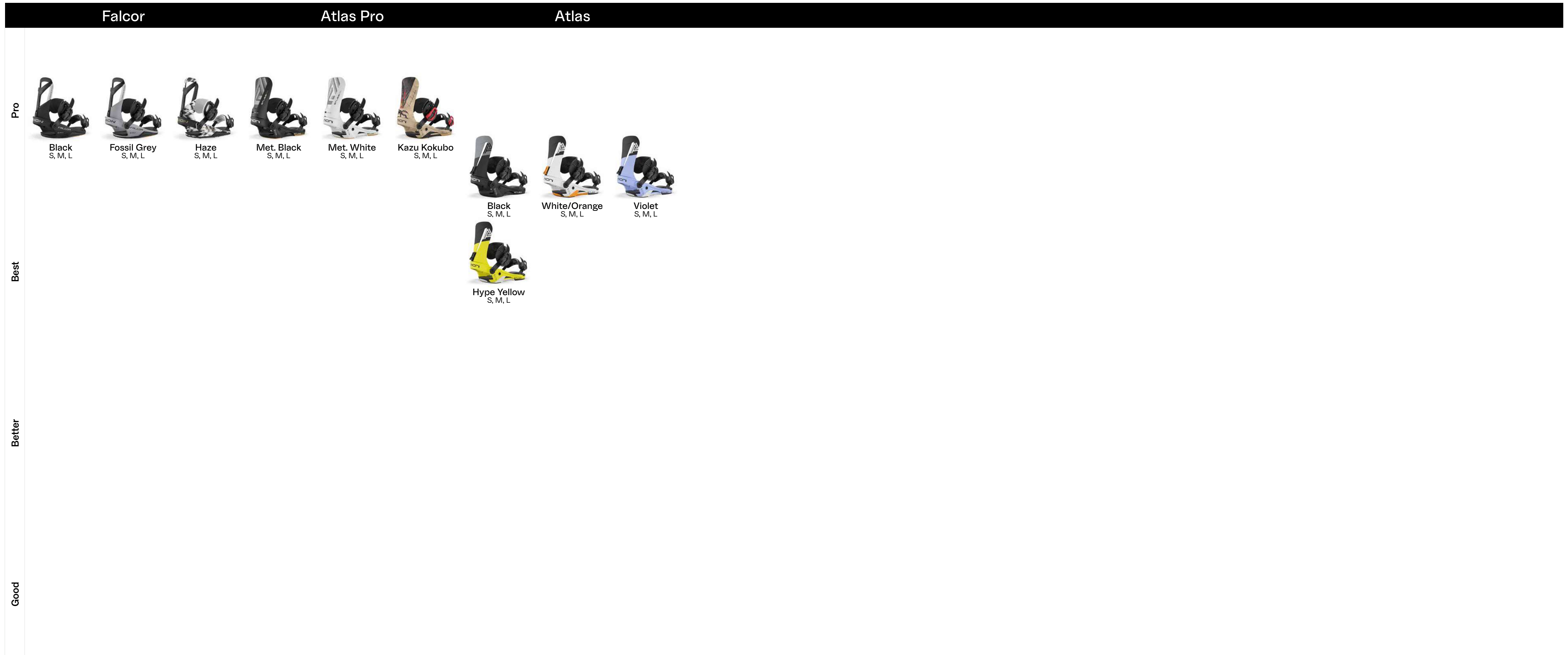

ALL MOUNTAIN

DURABLE

COMFORTABLE

BUILT FOR ALL TERRAIN

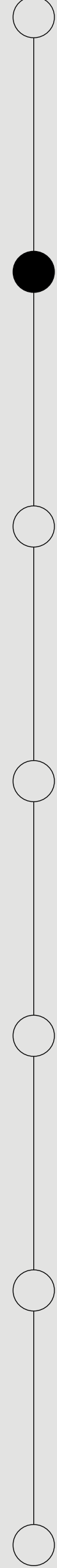
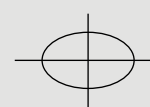
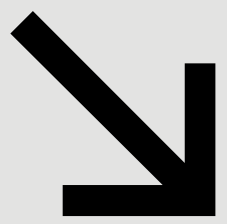

Rider: Torstein Horgmo | Photo: Celia Miller



Force / Men's Snowboard Binding



Product Description

The newest generation of the Union Force provides a smooth yet responsive ride feel that's built for any rider, any condition, and any terrain. More snowboarders around the globe choose to ride the Union Force than any other binding on the market today. Ride like the best—ride the Union Force.

Key Features

- The #1 Binding in Snowboarding
- XL Size Offering
- Marketed Model
- Ridden By: Miles Fallon and Benny Milam

Weight: 970 grams

Binding Performance

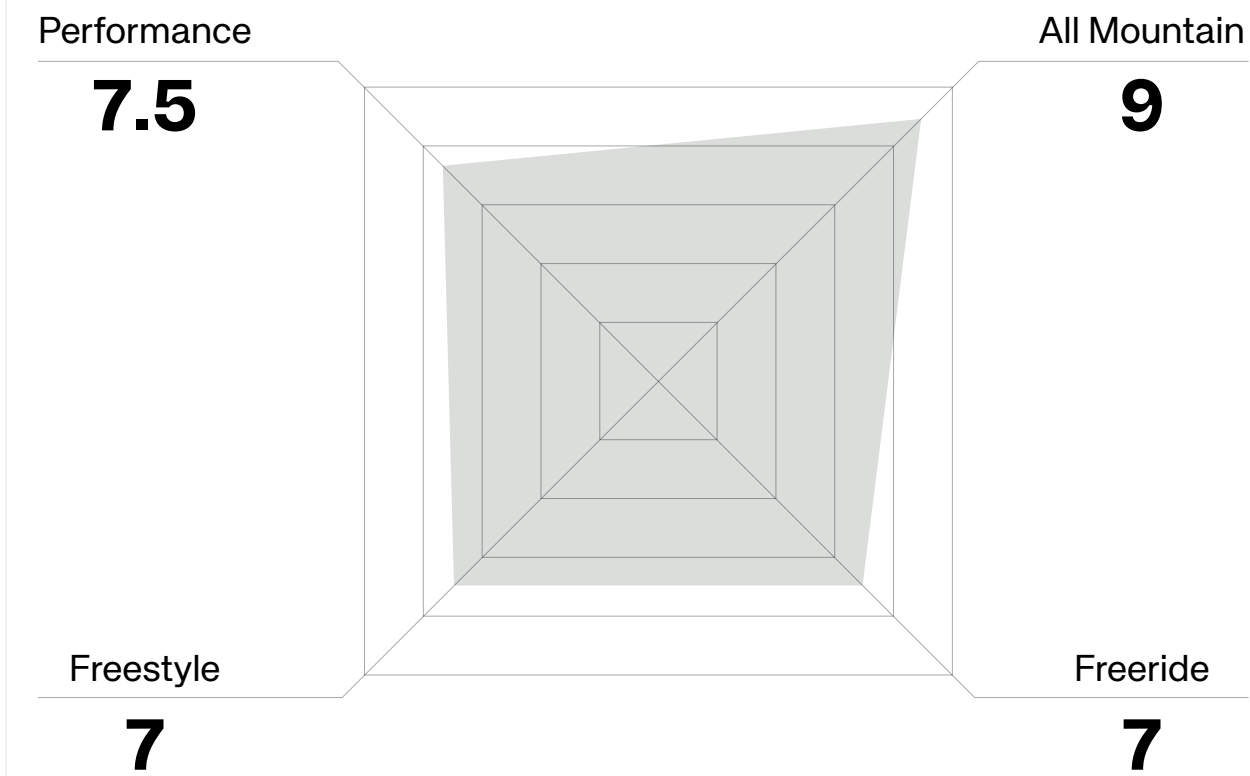

Binding Flex: 7/10



Compatibility:

4x2

4x4

Channel

Disk:

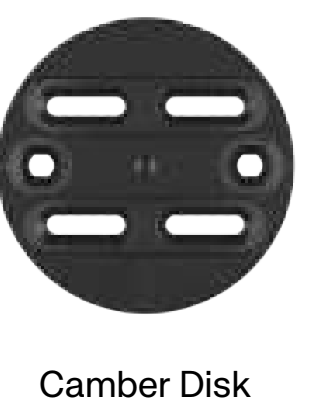

Technology

- | Technology | Value | New |
|---------------|-------------------------------------|-------------------------------------|
| BASEPLATE: | S9 Duraflex ST | <input type="checkbox"/> |
| BUSHING: | Molecular Bushing Suspension System | <input type="checkbox"/> |
| DISK COVER: | Non-Stick HP EVA | <input type="checkbox"/> |
| CANTING: | Yes | <input type="checkbox"/> |
| HIGHBACK: | S19 Duraflex ST | <input type="checkbox"/> |
| FLAD: | Tool-Less | <input type="checkbox"/> |
| HEELCUP: | Extruded 3D Aluminum | <input type="checkbox"/> |
| ANKLE STRAP: | Exoframe 6.0 w/Molecular Padding | <input type="checkbox"/> |
| TOE STRAP: | TS 5.0 Forcegrip | <input type="checkbox"/> |
| STRAP ADJUST: | Tool-Less 3.0 | <input checked="" type="checkbox"/> |
| RATCHETS: | Magnesium S2 w/Steel Base | <input type="checkbox"/> |
| HARDWARE: | Grade 8.8 Steel | <input type="checkbox"/> |



20"



01.

Color: **Black**
Size: **S, M, L, XL**

20"



02.

Color: **White**
Size: **S, M, L, XL**



03.

Color: **Brown**
Size: **S, M, L**



04.

Color: **Army Green** **X Marketed Colorway**
Size: **S, M, L**



05.

Color: **Cyber Lime**
Size: **S, M, L**

Angle: Back 3/4



Force

Colorways: 05 ● ○ ● ● ●



UNION BINDING COMPANY
STRONGER.

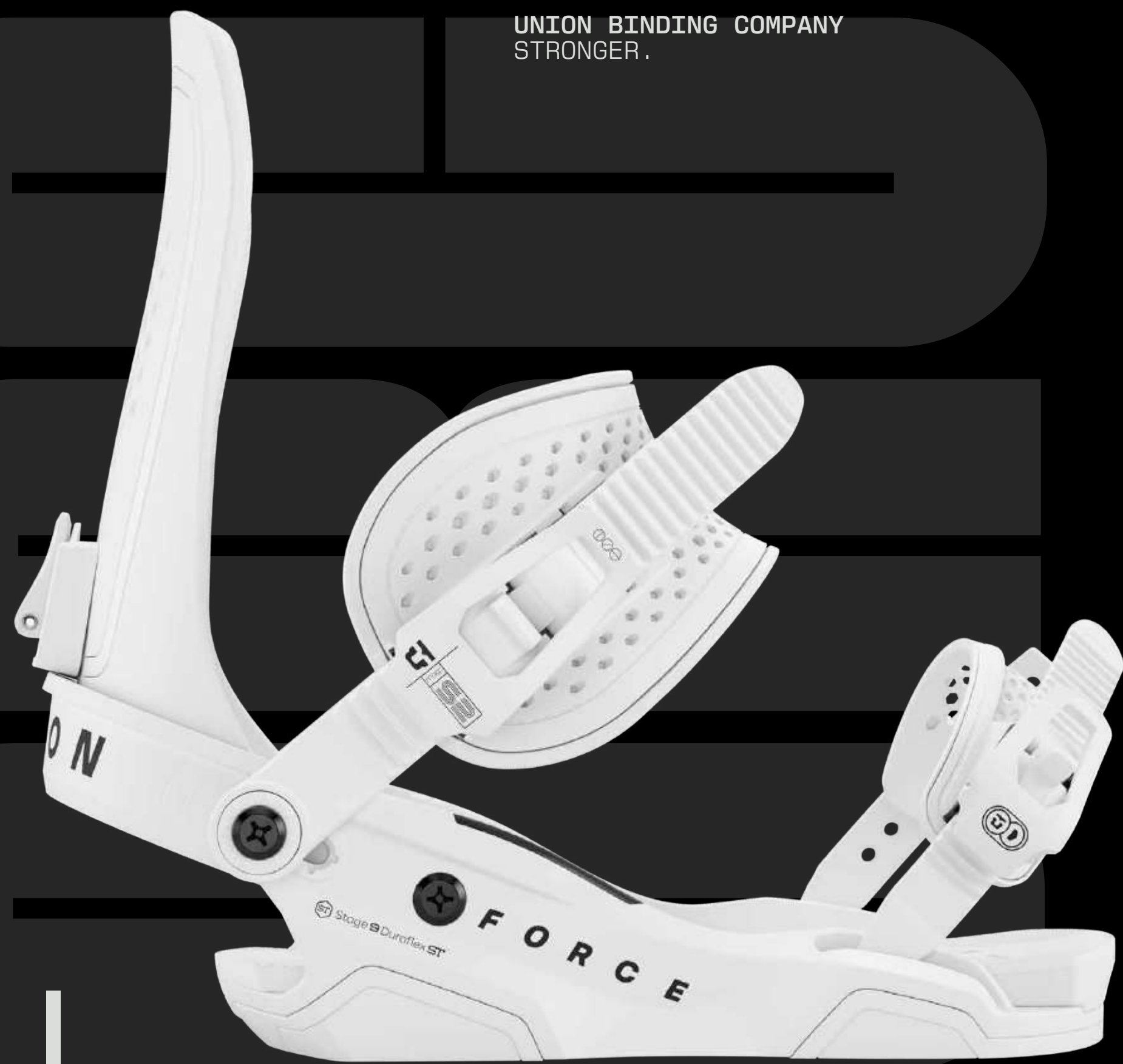

PERFORMANCE BINDING SYSTEM
TEAM TESTED



FORCE
20 YEARS

20 · 05

20 · 25



Trilogy / Women's Snowboard Binding



Product Description

Built for the next generation of women's snowboarders. The Union Trilogy provides a smooth and comfortable ride feel that's built for any rider, any condition, and any terrain. More women snowboarders choose to ride the Union Trilogy than any other snowboard binding on the market today. Ride like the best—ride the Union Trilogy.

Key Features

The #1 Women's Binding in Snowboarding

Cushioned Comfort

Marketed Model

Ridden By: Jamie Anderson and Mia Brooks

Weight: 900 grams

Binding Performance

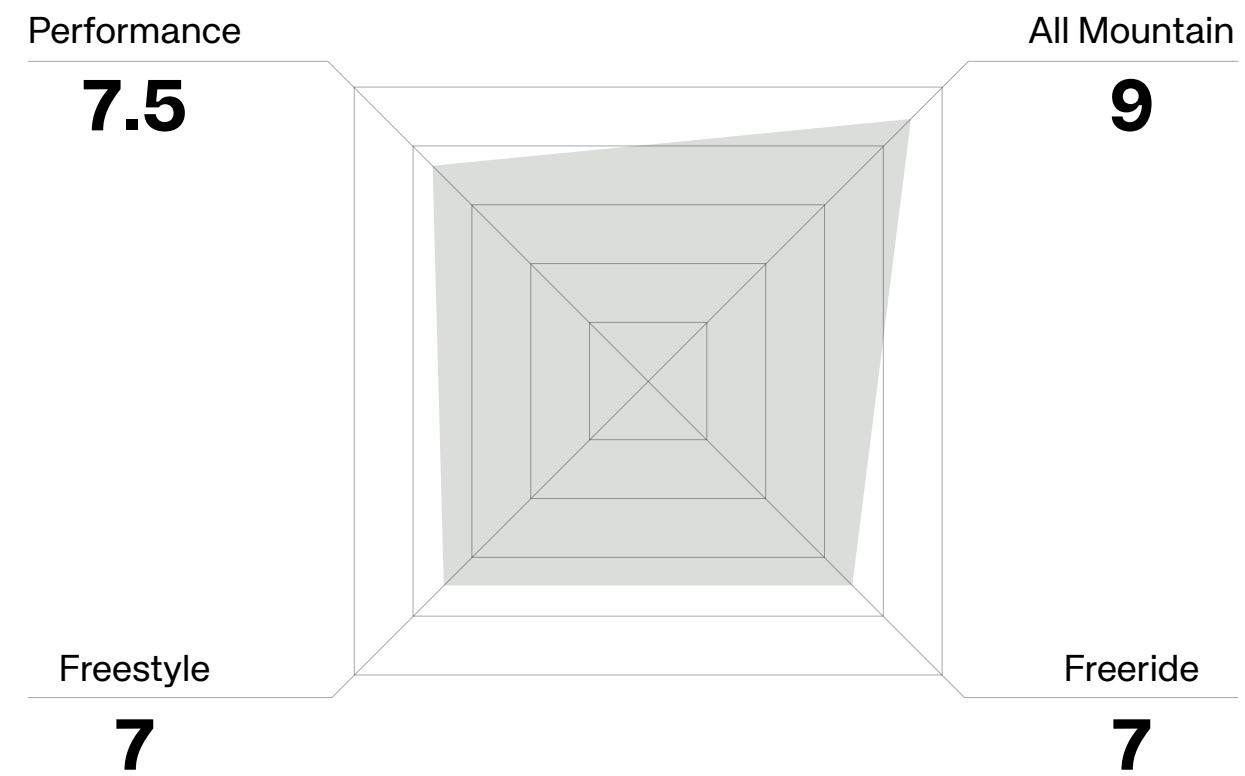

Binding Flex: 7/10



Compatibility:

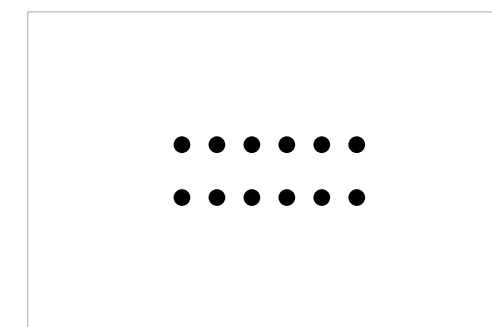

4x2

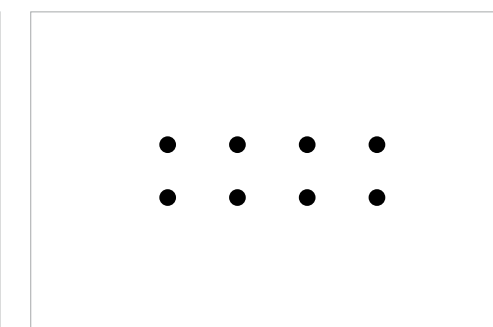

4x4

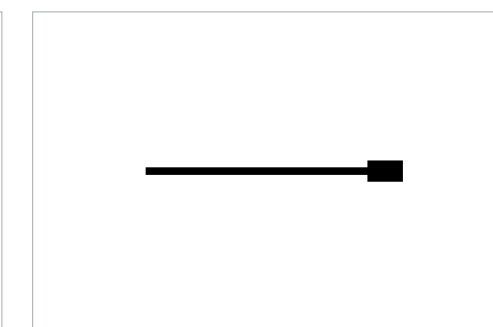

Channel

Disk:

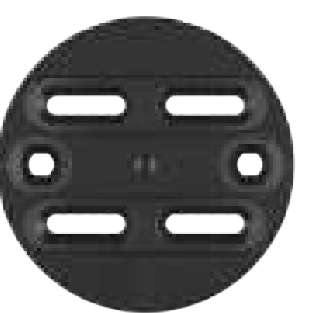

Camber Disk

Technology

New

- BASEPLATE: S9 Duraflex ST
- BUSHING: Molecular Bushing Suspension System
- DISK COVER: Non-Stick HP EVA
- CANTING: Yes
- HIGHBACK: S19 S Duraflex ST
- FLAD: Tool-Less
- HEELCUP: Extruded 3D Aluminum
- ANKLE STRAP: Exoframe 6.0 w/Molecular Padding
- TOE STRAP: TS 5.0 Forcegrip
- STRAP ADJUST: Tool-Less 3.0
- RATCHETS: Magnesium S2 w/Steel Base
- HARDWARE: Grade 8.8 Steel





01.

Color: **Black**
Size: **S, M, L**



02.

Color: **White**
Size: **S, M, L**



03.

Color: **Light Blue** **X Marketed Colorway**
Size: **S, M, L**



04.

Color: **Rose**
Size: **S, M, L**



Angle: Back 3/4

Trilogy

Colorways: 04 ● ○ ● ●



Force Classic / Men's Snowboard Binding



Product Description

Union's most iconic and best-selling binding model of all time. The Union Force Classic is a bombproof, all mountain snowboard binding designed to do it all. With minimal changes from season to season, the Force Classic is here to stay.

Key Features

- Iconic Union Style
- Shop Employee Favorite
- Always In Stock
- Ridden By: Chris Grenier

Weight: 860 grams

Binding Performance

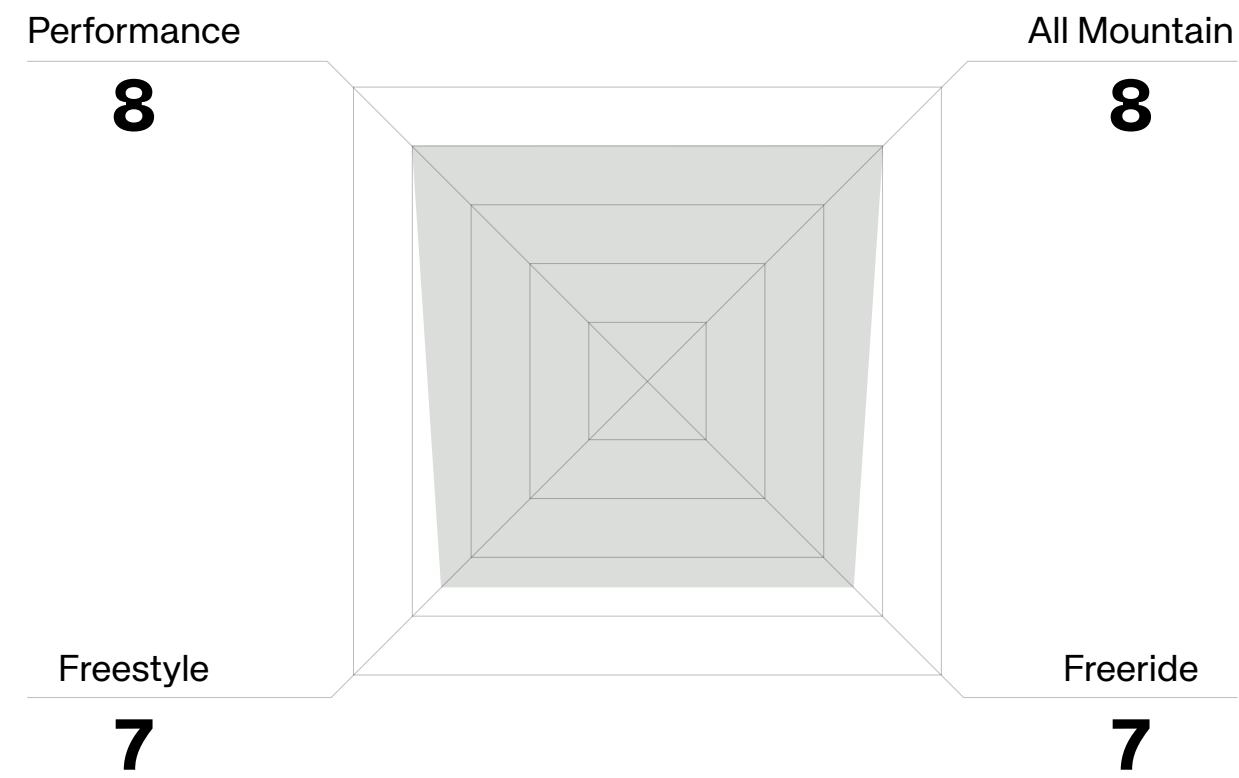

Binding Flex: 7/10



Compatibility:

4x2

4x4

Channel

Disk:

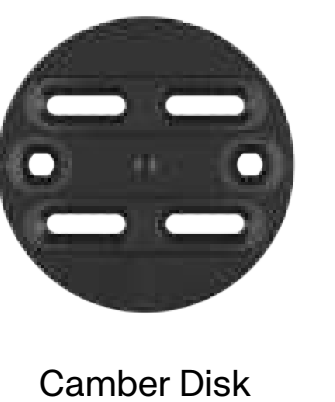

Technology

New

- BASEPLATE: Stage 4 Duraflex ST
- BUSHING: Multi-Density Thermoformed EVA
- DISK COVER: Thermoformed EVA
- CANTING: Yes
- HIGHBACK: Force Duraflex ST
- FLAD: Tool-Less
- HEELCUP: Extruded 3D Aluminum
- ANKLE STRAP: Exoframe 4.0
- TOE STRAP: TS 2.0 Rhombus
- STRAP ADJUST: Tool-Less
- RATCHETS: Magnesium
- HARDWARE: Grade 8.8 Steel





01.

Color: **Black**
Size: **S, M, L**

👉 Carry Forward



02.

Color: **White**
Size: **S, M, L**

👉 Carry Forward



Angle: Back 3/4

Force Classic

Colorways: 02 ● ○



Trilogy Classic / Women's Snowboard Binding



Product Description

Union's most iconic and best-selling women's binding model of all time. The Union Trilogy Classic is a comfortable, all mountain snowboard binding designed to do it all. With minimal changes from season to season, the Trilogy Classic is here to stay.

Key Features

- Iconic Union Style
- Shop Employee Favorite
- Always In Stock
- Ridden By: Darrah Reid-McLean

Weight: 800 grams

Binding Performance

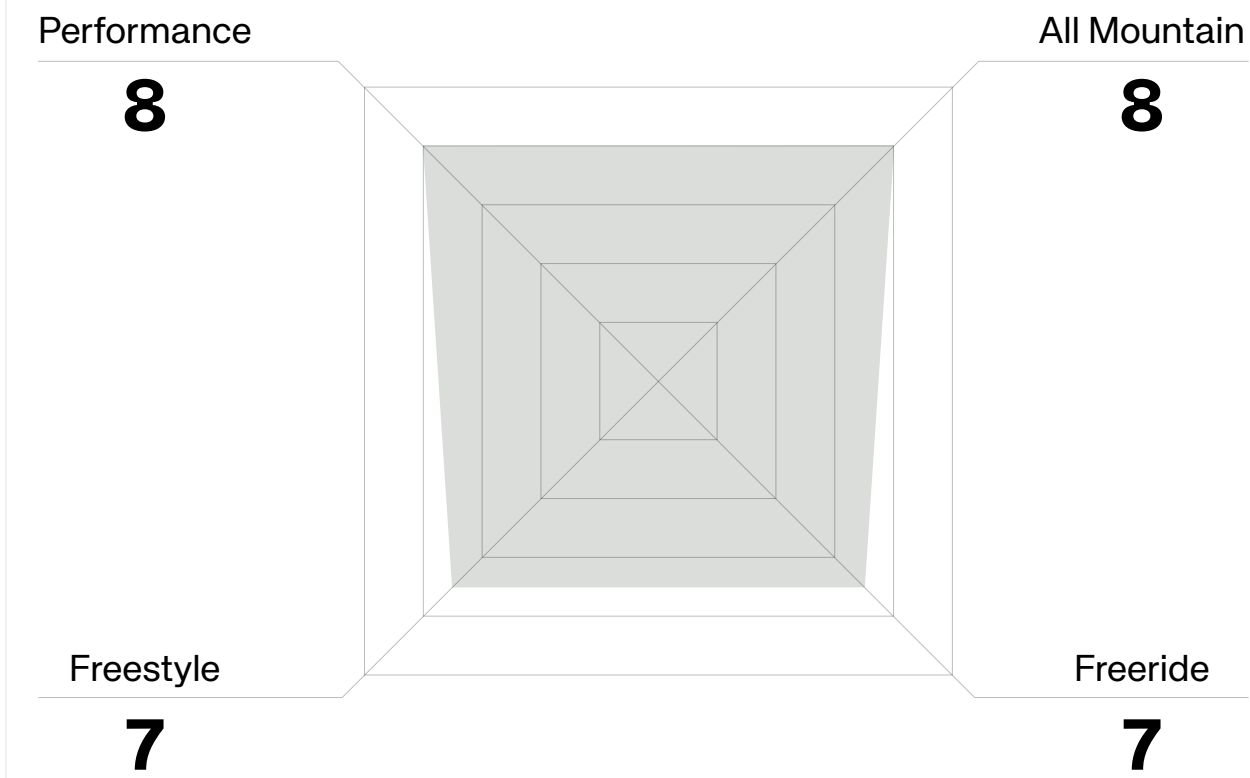

Binding Flex: 7/10

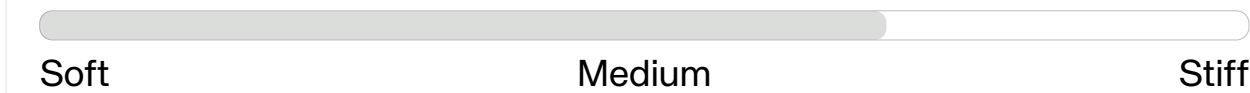

Compatibility:

4x2

4x4

Channel

Disk:

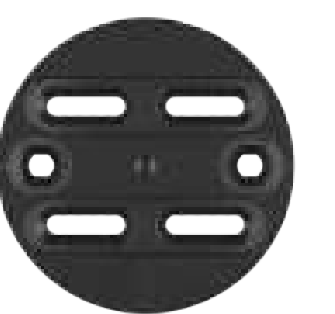

Camber Disk

Technology

- | Technology | Value | New |
|---------------|--------------------------------|--------------------------|
| BASEPLATE: | Stage 4 Duraflex ST | <input type="checkbox"/> |
| BUSHING: | Multi-Density Thermoformed EVA | <input type="checkbox"/> |
| DISK COVER: | Thermoformed EVA | <input type="checkbox"/> |
| CANTING: | Yes | <input type="checkbox"/> |
| HIGHBACK: | Force Duraflex ST | <input type="checkbox"/> |
| FLAD: | Tool-Less | <input type="checkbox"/> |
| HEELCUP: | Extruded 3D Aluminum | <input type="checkbox"/> |
| ANKLE STRAP: | Exoframe 4.0 | <input type="checkbox"/> |
| TOE STRAP: | TS 2.0 Rhombus | <input type="checkbox"/> |
| STRAP ADJUST: | Tool-Less | <input type="checkbox"/> |
| RATCHETS: | Magnesium | <input type="checkbox"/> |
| HARDWARE: | Grade 8.8 Steel | <input type="checkbox"/> |





01.
Color: **Black**
Size: **S, M, L**  Carry Forward



02.
Color: **White**
Size: **S, M, L**  Carry Forward



Angle: Back 3/4

Trilogy Classic

Colorways: 02 ● ○



STR / Men's Snowboard Binding

SHRED Donation and Partnership



Product Description

All-day comfort with enough control to enjoy the entire mountain. The Union STR is a durable, mid-flexing, all mountain men's snowboard binding designed for beginner to intermediate snowboarders looking to push their snowboarding to the next level.

Key Features

- 2% Giveback To Shred Foundation
- Lifetime Warranty Baseplate
- Durable Materials
- Budget Friendly

Weight: 840 grams

Binding Performance

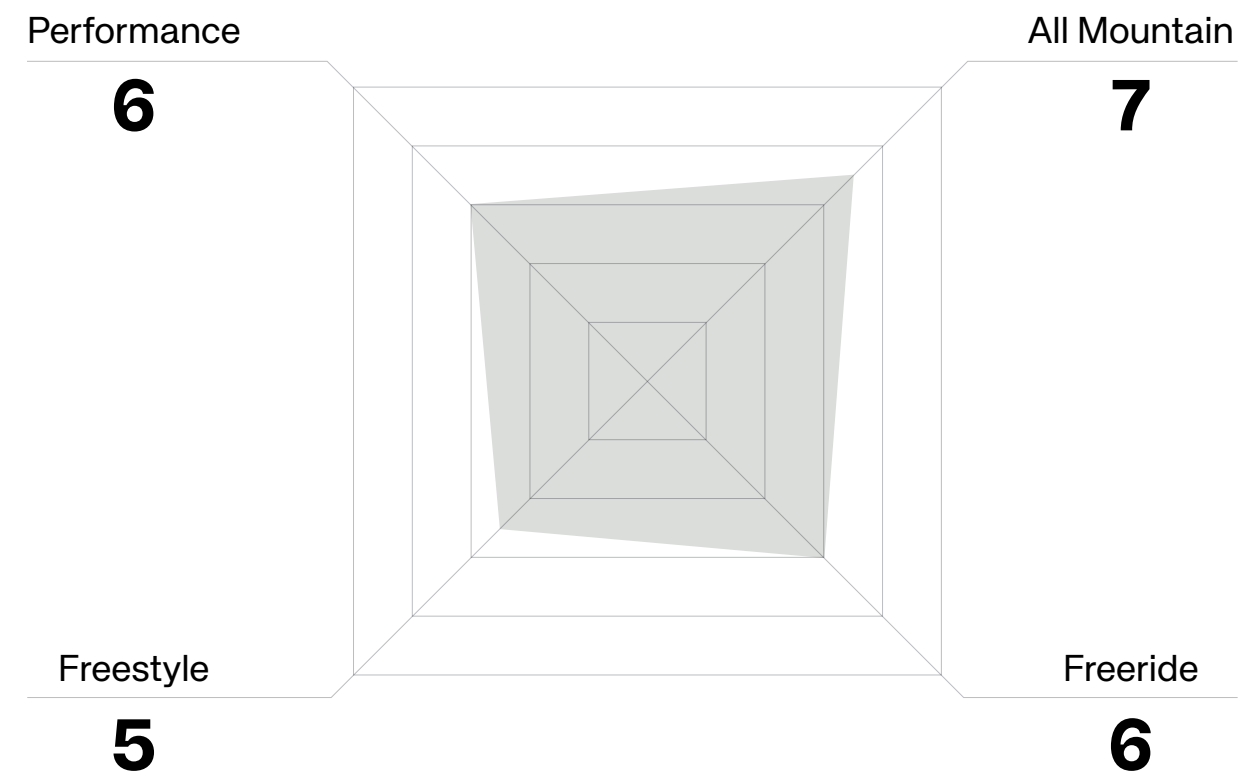

Binding Flex: 6/10



Compatibility:

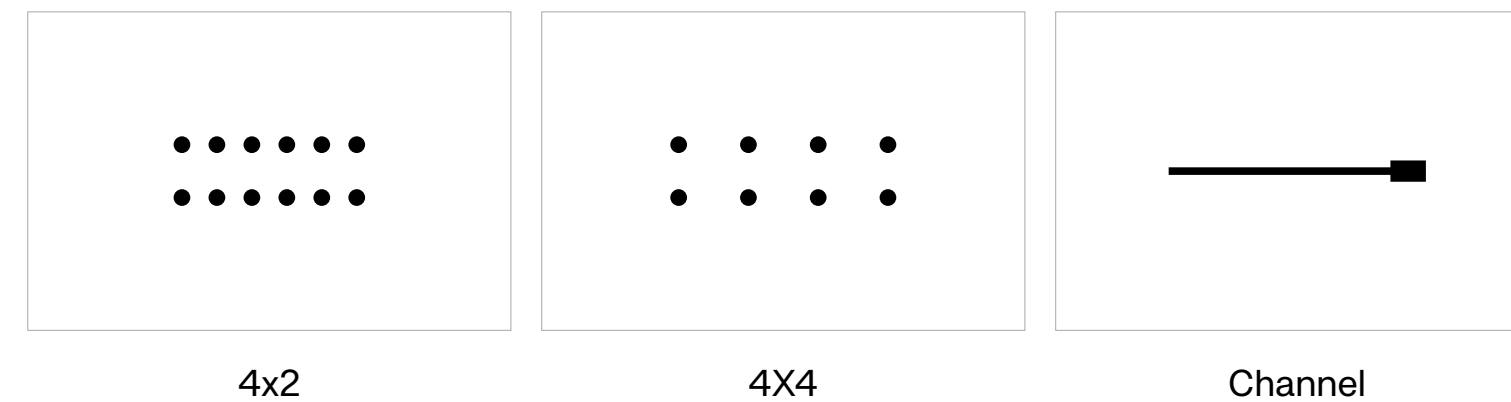

Disk:

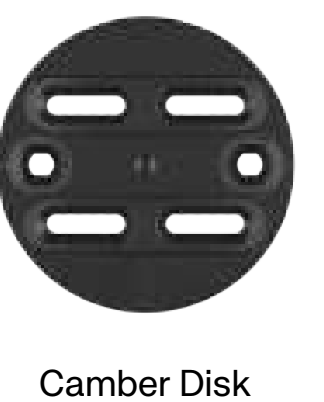

Technology

New

- BASEPLATE: Stage 5 Duraflex
- BUSHING: EXT Thermoformed EVA
- DISK COVER: Thermoformed EVA
- CANTING: Yes
- HIGHBACK: S11 Duraflex
- FLAD: Tool-Less
- HEELCUP: Extruded 3D Aluminum
- ANKLE STRAP: Exoframe 3.0
- TOE STRAP: TS 2.1 Tiles
- STRAP ADJUST: Traditional
- RATCHETS: Alu S2 w/Steel
- HARDWARE: Grade 8.8 Steel





01. Color: **Black** Size: **S, M, L** **👉 Carry Forward**



02. Color: **Bone** Size: **S, M, L**



03. Color: **Camo** Size: **S, M, L** **✕ Marketed Colorway**



04. Color: **Purple** Size: **S, M, L**



Angle: Back 3/4

STR

Colorways: 04 ● ● ● ●



Juliet / Women's Snowboard Binding



Product Description

All-day comfort with enough control to enjoy the entire mountain. The Union Juliet is a comfortable, mid-flexing, all mountain women's snowboard binding designed for beginner to intermediate snowboarders looking to push their snowboarding to the next level.

Key Features

- 2% Giveback To B4BC
- Lifetime Warranty Baseplate
- Durable Materials
- Budget Friendly

Weight: 770 grams

Binding Performance

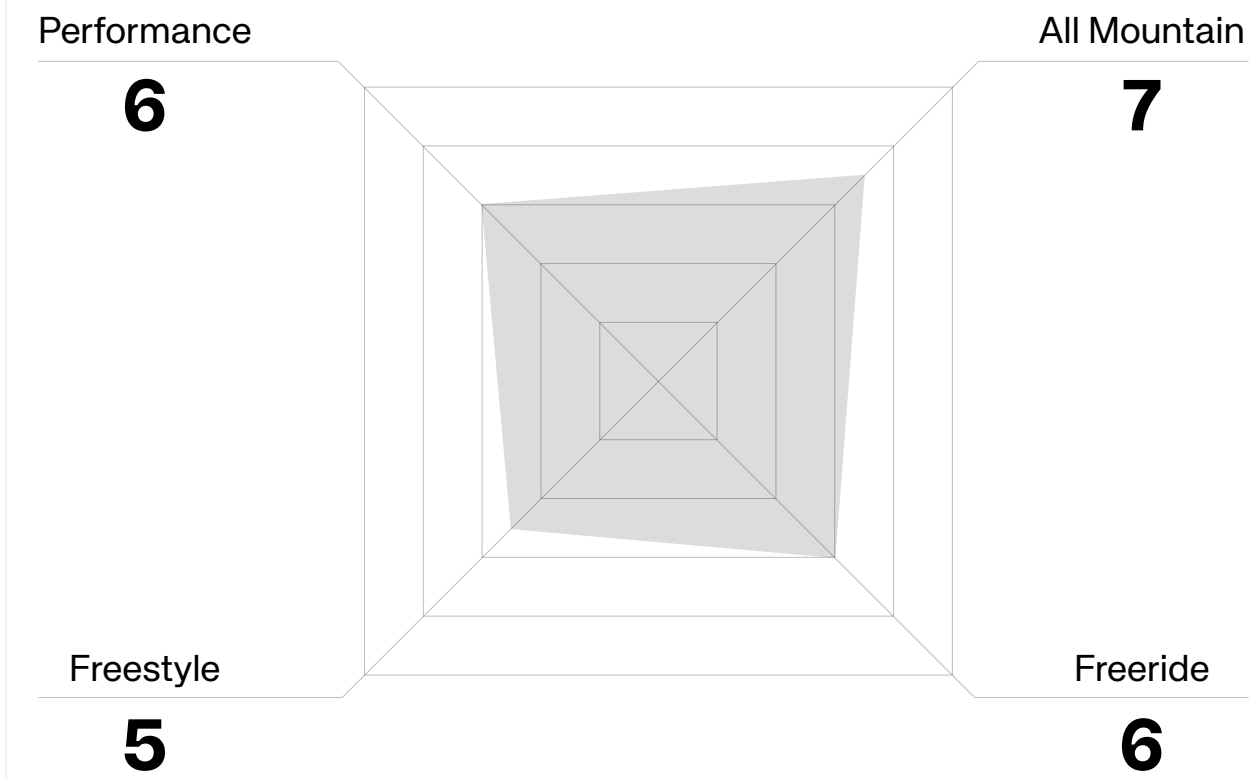

Binding Flex: 6/10

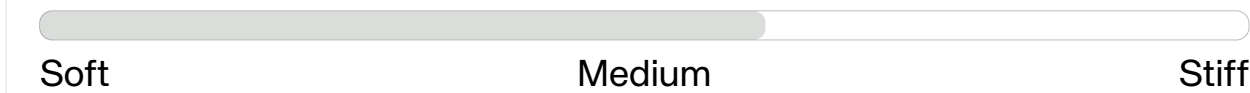

Compatibility:

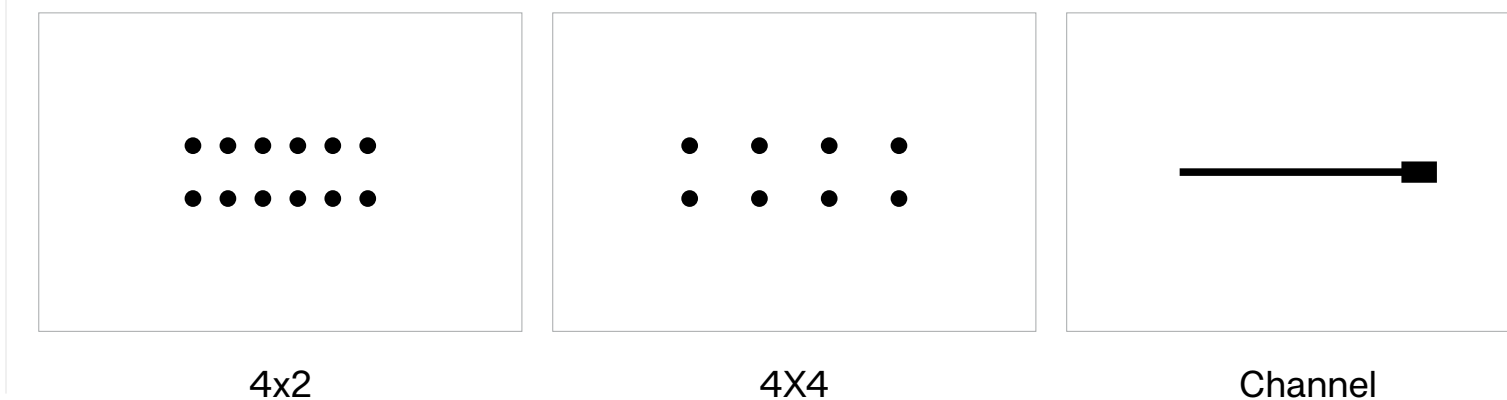

Disk:

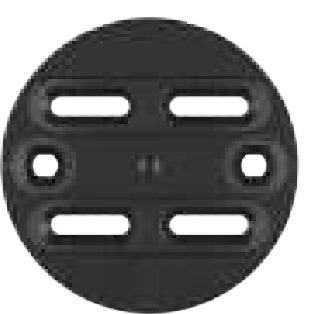

Camber Disk





01.
Color: **Black**
Size: **S, M, L** **👉 Carry Forward**



02.
Color: **Sand Pink**
Size: **S, M, L**



03.
Color: **Tie Dye** **✗ Marketed Colorway**
Size: **S, M, L**























Angle: Back 3/4

Juliet

Colorways: 03 ● ● ●



All Mountain Overview

	Force	Trilogy	Force Classic	Trilogy Classic	STR	Juliet					
Pro											
Best	 Black S, M, L, XL	 White S, M, L, XL	 Brown S, M, L	 Black S, M, L	 White S, M, L	 Light Blue S, M, L					
Better	 Army Green S, M, L	 Cyber Lime S, M, L	 Rose S, M, L	 Black S, M, L	 White S, M, L	 Black S, M, L	 White S, M, L				
Good					 Black S, M, L	 Bone S, M, L	 Camo S, M, L	 Black S, M, L	 Sand Pink S, M, L	 Tie Dye S, M, L	
					 Purple S, M, L						



FREESTYLE

CUSHIONED

SOFT & SURFY

NATURAL BOARD FEEL

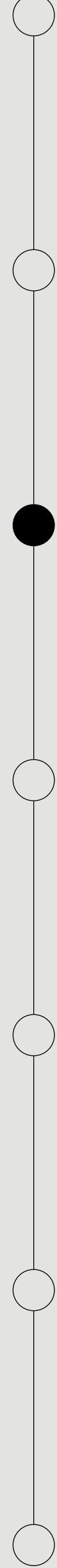
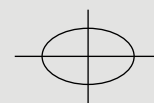
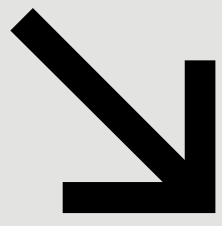

Rider: Benny Milani | Photo: Keke Leppala



Ultra / Men's Snowboard Binding



Product Description

Strap in to the most comfortable snowboard binding ever developed. The Union Ultra provides a flexible and cushioned ride feel like you've never experienced before. Each component of the Ultra acts as a suspension system for your snowboard boots, loading and unloading with each movement as you ride. Welcome to the future of snowboard binding design.

Weight: 865 grams

Binding Performance

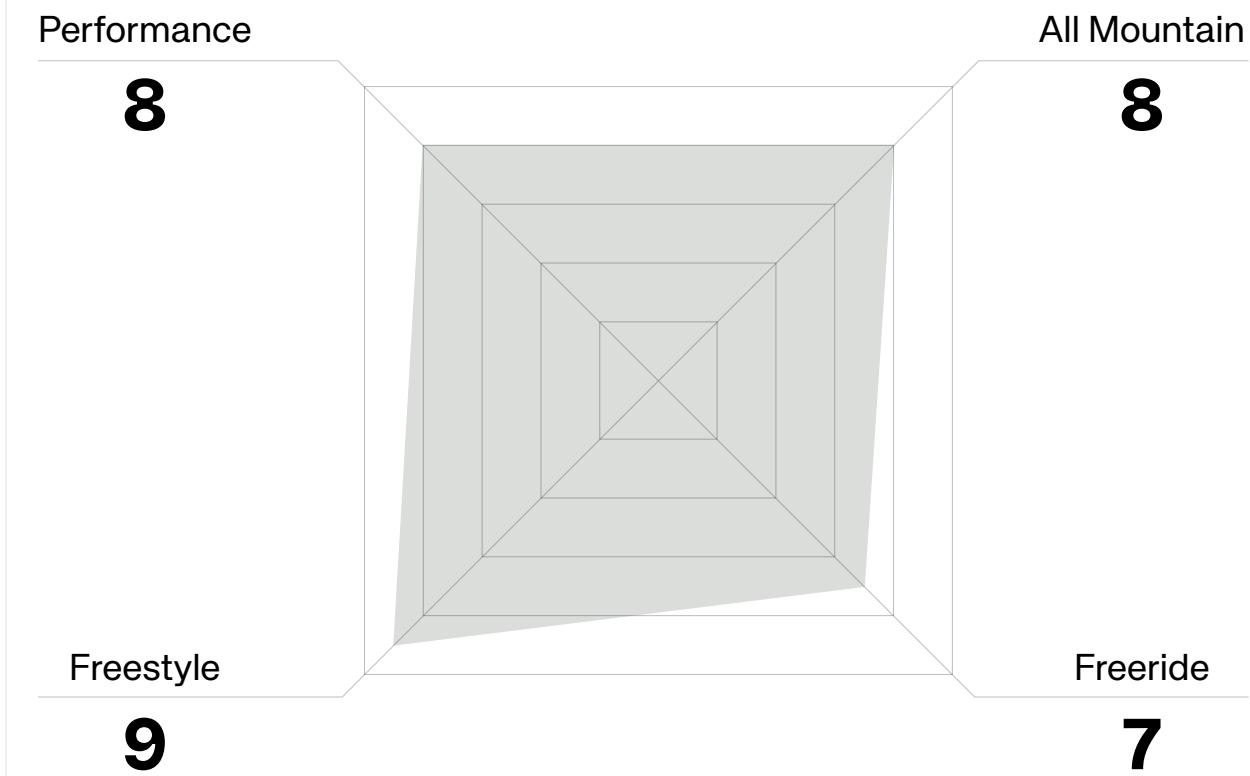

Binding Flex: 6/10



Compatibility:

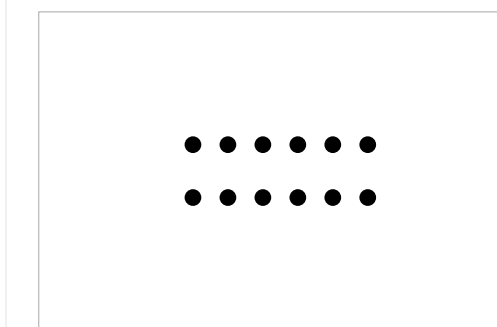

4x2

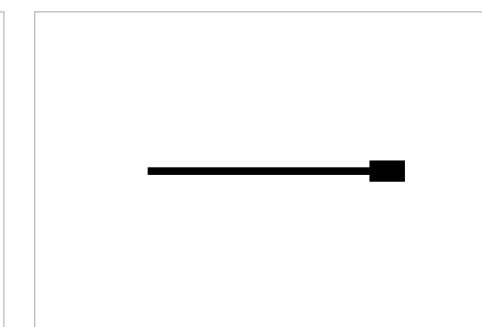

Channel

Disk:

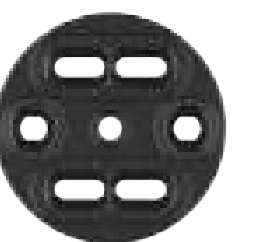

Mini Disk

Key Features

Union Exclusive Bushing Technology

Upgraded Ankle Strap Design

Marketed Model

Ridden By: Scott Stevens and Gigi Rűf

Technology

New

BASEPLATE:	S11 ASYM Duraflex ST	<input type="checkbox"/>
BUSHING:	Molecular Bushing w/TPE Outsole	<input type="checkbox"/>
DISK COVER:	Non Stick + Extragrip	<input type="checkbox"/>
CANTING:	No	<input type="checkbox"/>
HIGHBACK:	S15 Ultra Duraflex ST	<input type="checkbox"/>
FLAD:	No Flad	<input type="checkbox"/>
HEELCUP:	Extruded 3D Aluminum w/Astro Washer	<input type="checkbox"/>
ANKLE STRAP:	Hybrid 1.0	<input checked="" type="checkbox"/>
TOE STRAP:	TS 5.0 Ultragrip	<input type="checkbox"/>
STRAP ADJUST:	Tool-Less 3.0	<input checked="" type="checkbox"/>
RATCHETS:	Magnesium S1 w/Steel Base	<input type="checkbox"/>
HARDWARE:	Grade 8.8 Steel	<input type="checkbox"/>



01.

Color: **Black**
Size: **S, M, L**



02.

Color: **Ice Grey**
Size: **S, M, L**



03.

Color: **Sage**
Size: **S, M, L**



04.

Color: **Hype Yellow** **X Marketed Colorway**
Size: **S, M, L**



05.

Color: **Arthur Longo** **X Marketed Colorway**
Size: **XS, S, M, L**



Angle: Back 3/4

Ultra

Colorways: 05 ● ● ● ● ○



ULTRA ARTHUR LONGO

FLY HIGH, LAND SOFT. THE LIMITED EDITION ARTHUR LONGO ULTRA IS YOUR KEY TO GOOD TIMES ON AND OFF THE MOUNTAIN. ARTWORK BY THE ONE AND ONLY, ARTHUR LONGO.

the creatures of
our dreams



Ultra / Women's Snowboard Binding



Product Description

Strap in to the most comfortable snowboard binding ever developed. The Union Ultra provides a flexible and cushioned ride feel like you've never experienced before. Each component of the Ultra acts as a suspension system for your snowboard boots, loading and unloading with each movement as you ride. Welcome to the future of snowboard binding design.

Weight: 775 grams

Binding Performance

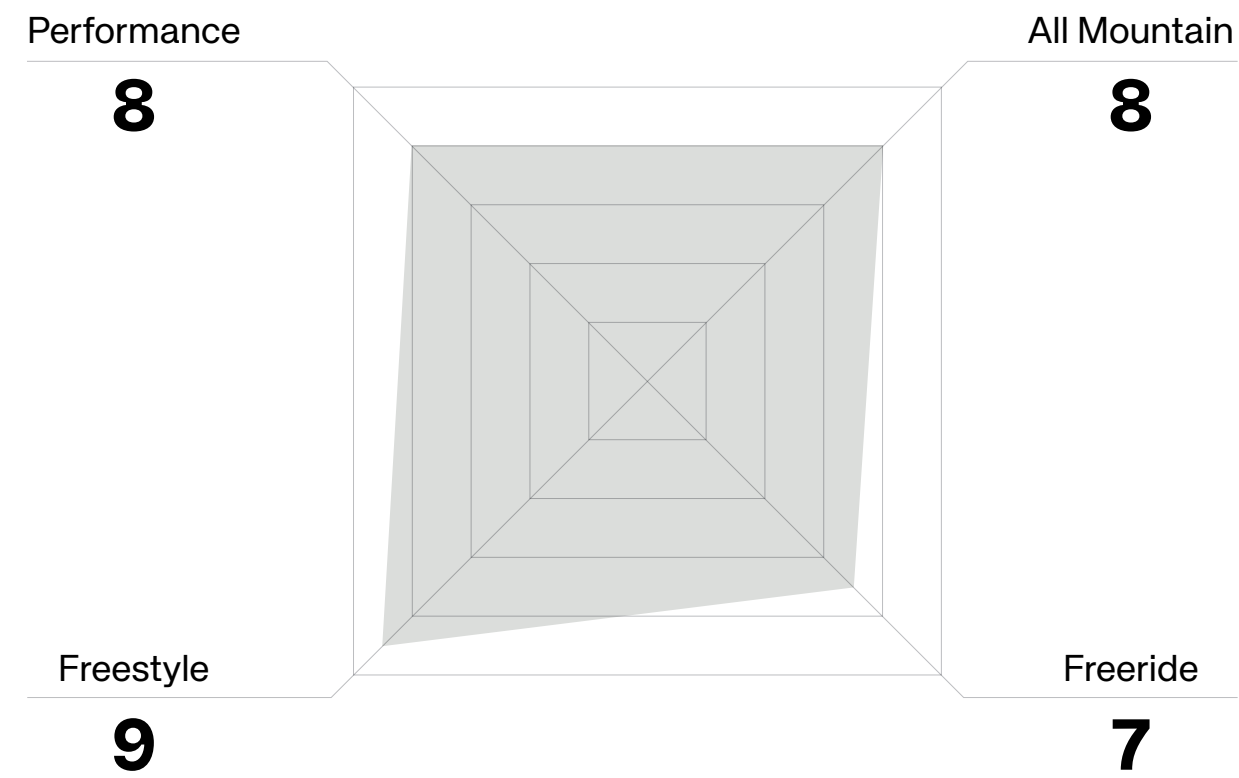

Binding Flex: 6/10



Compatibility:

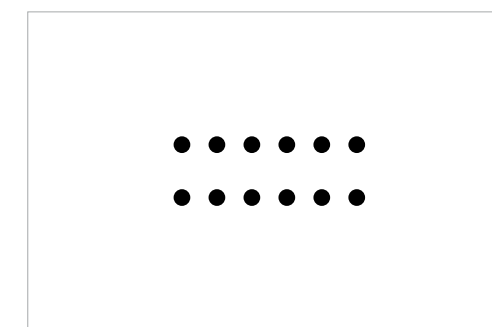

4x2

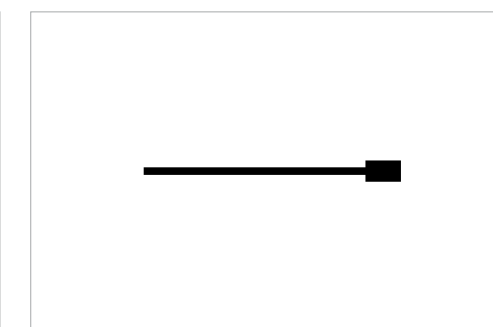

Channel

Disk:

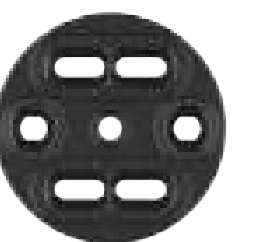

Mini Disk

Key Features

Union Exclusive Bushing Technology

Upgraded Ankle Strap Design

Marketed Model

Ridden By: Jess Kimura and Henna Ikola

Technology

New

BASEPLATE:	S11 ASYM Duraflex ST	<input type="checkbox"/>
BUSHING:	Molecular Bushing w/TPE Outsole	<input type="checkbox"/>
DISK COVER:	Non Stick + Extragrip	<input type="checkbox"/>
CANTING:	No	<input type="checkbox"/>
HIGHBACK:	S15 Ultra Duraflex ST	<input type="checkbox"/>
FLAD:	No Flad	<input type="checkbox"/>
HEELCUP:	Extruded 3D Aluminum w/Astro Washer	<input type="checkbox"/>
ANKLE STRAP:	Hybrid 1.0	<input checked="" type="checkbox"/>
TOE STRAP:	TS 5.0 Ultragrip	<input type="checkbox"/>
STRAP ADJUST:	Tool-Less 3.0	<input checked="" type="checkbox"/>
RATCHETS:	Magnesium S1 w/Steel Base	<input type="checkbox"/>
HARDWARE:	Grade 8.8 Steel	<input type="checkbox"/>



01.

Color: **Black**
Size: **S, M, L**



02.

Color: **Ice Grey**
Size: **S, M, L**



03.

Color: **Pink**
Size: **S, M, L**



04.

Color: **Jess Kimura** **X Marketed Colorway**
Size: **S, M, L**



Angle: Back 3/4

Ultra

Colorways: 04 ● ● ● ●



JESS KIMURA

* + * + *

ULTRA

Limited Edition



Tough enough for Jess Kimura, tough enough for you. The Ultra is the binding that Jess trusts every time she straps in. Art by Aryn Chapman and Ellie Nixon.



JESS X UNION



Strata / Men's Snowboard Binding



Product Description

Union's #1 men's park and freestyle snowboard binding. The soft, surfy and shock absorbing ride feel of the Union Strata is perfect for snowboarders looking to cruise the park or surf the whole mountain. Strap into pair and unlock your snowboard's true flex. A Union fan favorite!

Key Features

- Upgraded Bushing Material
- Upgraded Ankle Straps
- Marketed Model
- Ridden By: Brandon Cocard and Austin Vizz

Weight: 895 grams

Binding Performance

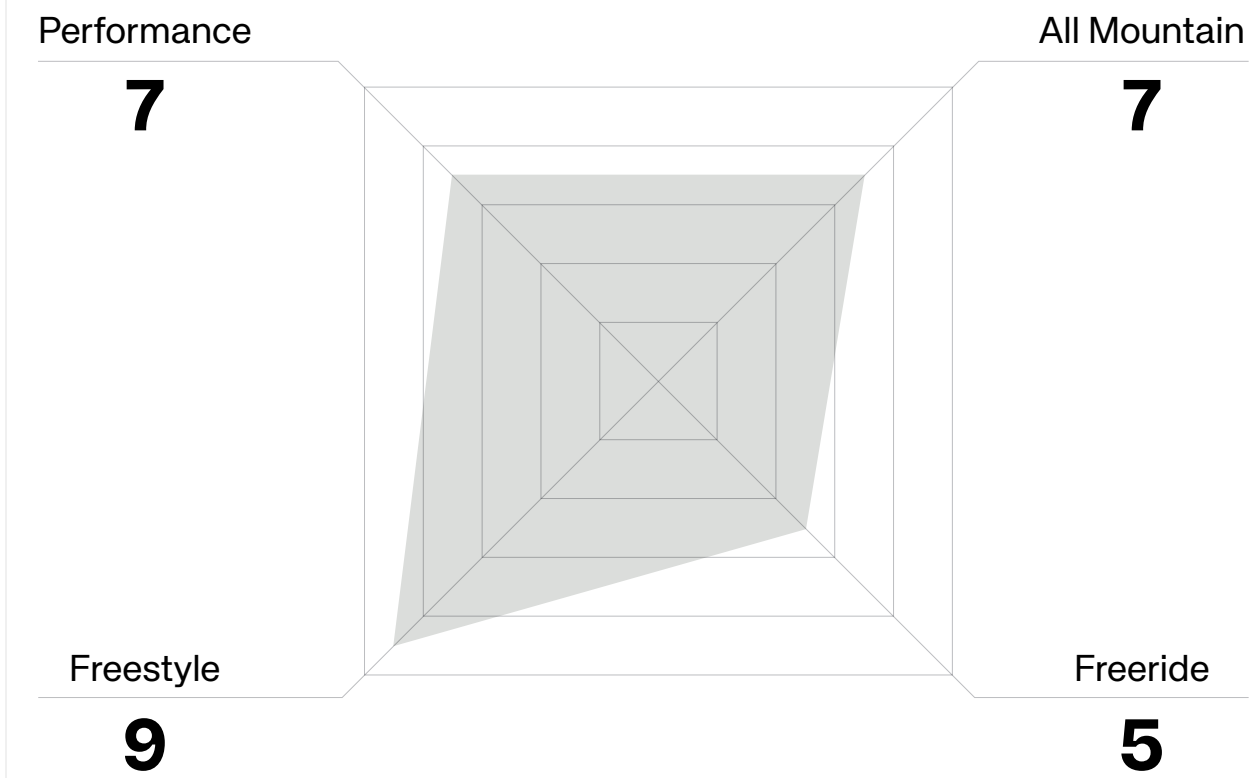

Binding Flex: 5/10



Technology

New

- BASEPLATE: S6 Duraflex ST
- BUSHING: OTE Fused Vaporlite 2.0
- DISK COVER: Thermoformed EVA
- CANTING: Yes
- HIGHBACK: Strata Duraflex ST
- FLAD: Classic
- HEELCUP: Extruded 3D Aluminum
- ANKLE STRAP: Forma Hybrid
- TOE STRAP: TS 2.1
- STRAP ADJUST: Tool-Less
- RATCHETS: Aluminum S2 w/Steel Base
- HARDWARE: Grade 8.8 Steel

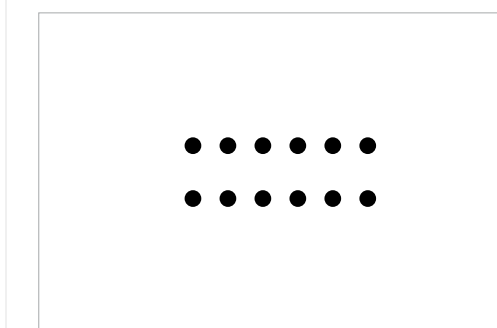

4x2

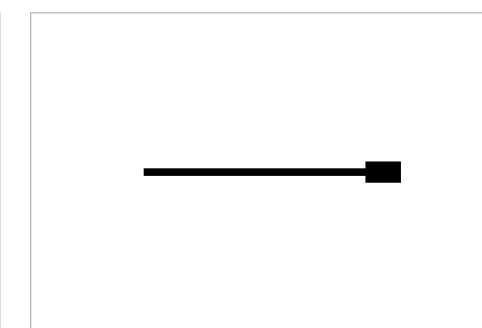

Channel

Disk:

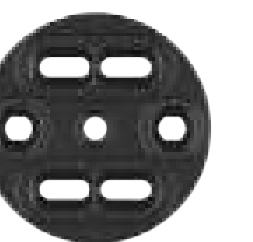

Mini Disk





01.

Color: **Black**
Size: **S, M, L**



02.

Color: **Sand** **X Marketed Colorway**
Size: **S, M, L**



03.

Color: **Grey Violet**
Size: **S, M, L**



04.

Color: **Olive Green**
Size: **S, M, L**



Color: **Orange**
Size: **S, M, L**



Angle: Back 3/4

Strata

Colorways: 05 ● ● ● ● ●



Legacy / Women's Snowboard Binding



Product Description

Union's #1 women's park and freestyle snowboard binding. The soft, surfy and shock absorbing ride feel of the Union Legacy is perfect for snowboarders looking to cruise the park or surf the whole mountain. Strap into pair and unlock your snowboard's true flex. A Union fan favorite!

Key Features

- Upgraded Bushing Material
- Upgraded Ankle Straps
- Marketed Model
- Ridden By: Jib Gurl

Weight: 870 grams

Binding Performance

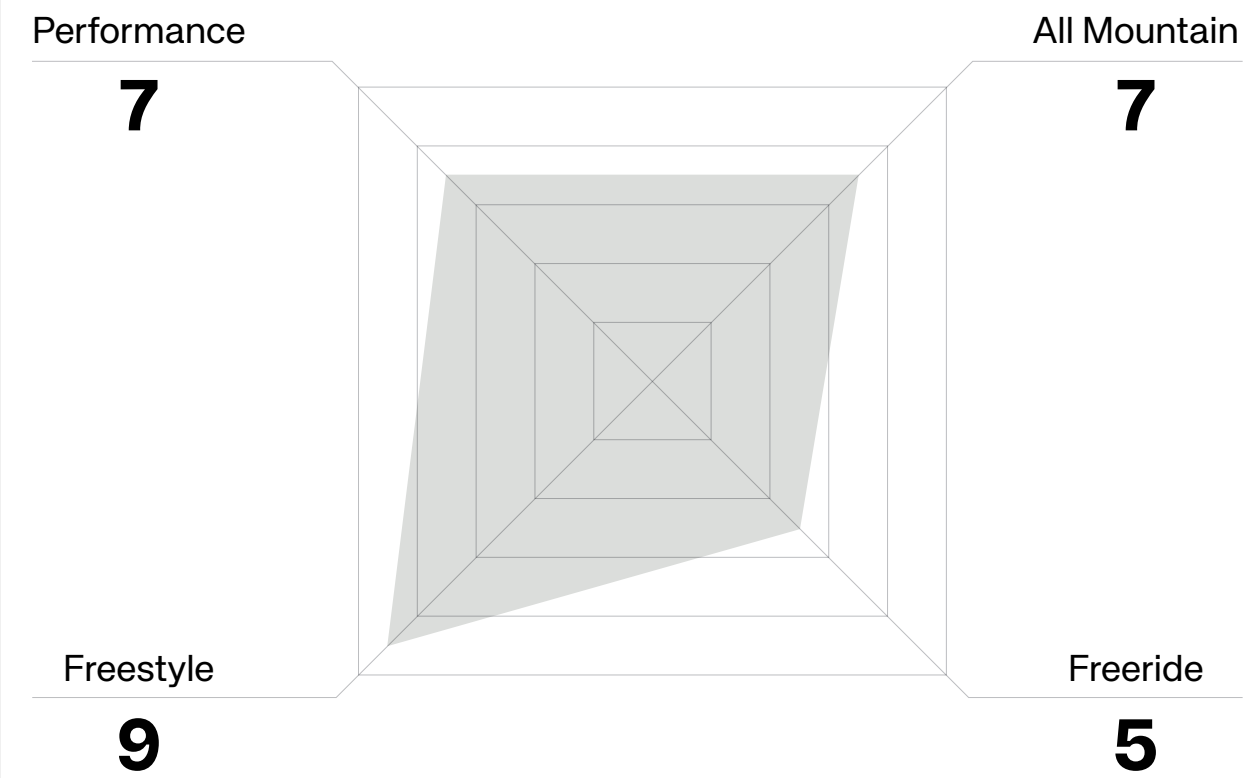

Binding Flex: 5/10



Compatibility:

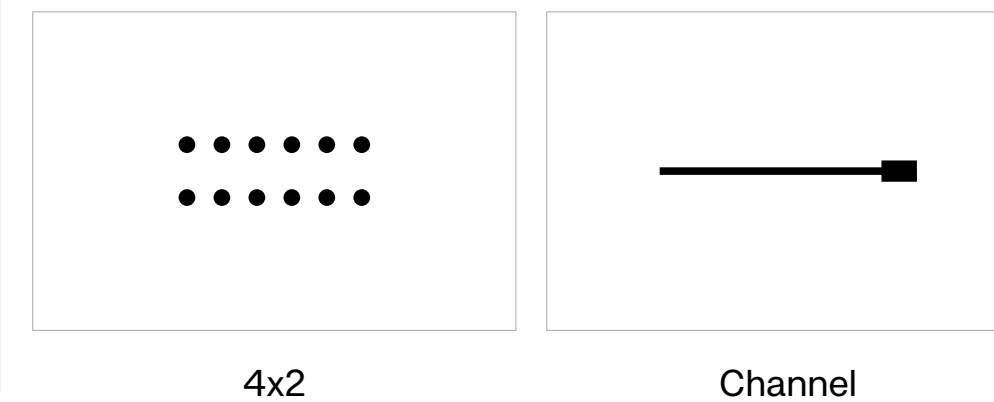

Disk:

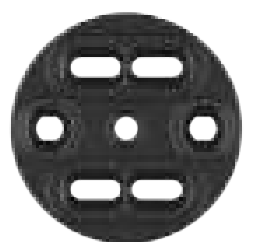

Mini Disk

Technology

New

- BASEPLATE: S6 Duraflex ST
- BUSHING: OTE Fused Vaporlite 2.0
- DISK COVER: Thermoformed EVA
- CANTING: Yes
- HIGHBACK: Strata Duraflex ST
- FLAD: Classic
- HEELCUP: Extruded 3D Aluminum
- ANKLE STRAP: Forma Hybrid
- TOE STRAP: TS 2.1
- STRAP ADJUST: Tool-Less
- RATCHETS: Aluminum S2 w/Steel Base
- HARDWARE: Grade 8.8 Steel





01.

Color: **Midnight**
Size: **S, M, L**



02.

Color: **Grey**
Size: **S, M, L**



03.

Color: **Aqua**
Size: **S, M, L**



04.

Color: **Pink** **X Marketed Colorway**
Size: **S, M, L**



Angle: Back 3/4

Legacy

Colorways: 04 ● ● ● ●



Flite Pro / Men's Snowboard Binding



Product Description

Strap in to the lightest men's snowboard binding on the market. The Union Flite Pro is a lightweight, soft-flexing, freestyle snowboard binding for beginner to intermediate snowboarders. Perfect for learning to ride the entire mountain or taking your first park laps.

Key Features

- Upgraded Straps and Highback
- Budget Friendly
- Lightweight
- Compatible With All Mounting Systems

Weight: 670 grams

Binding Performance

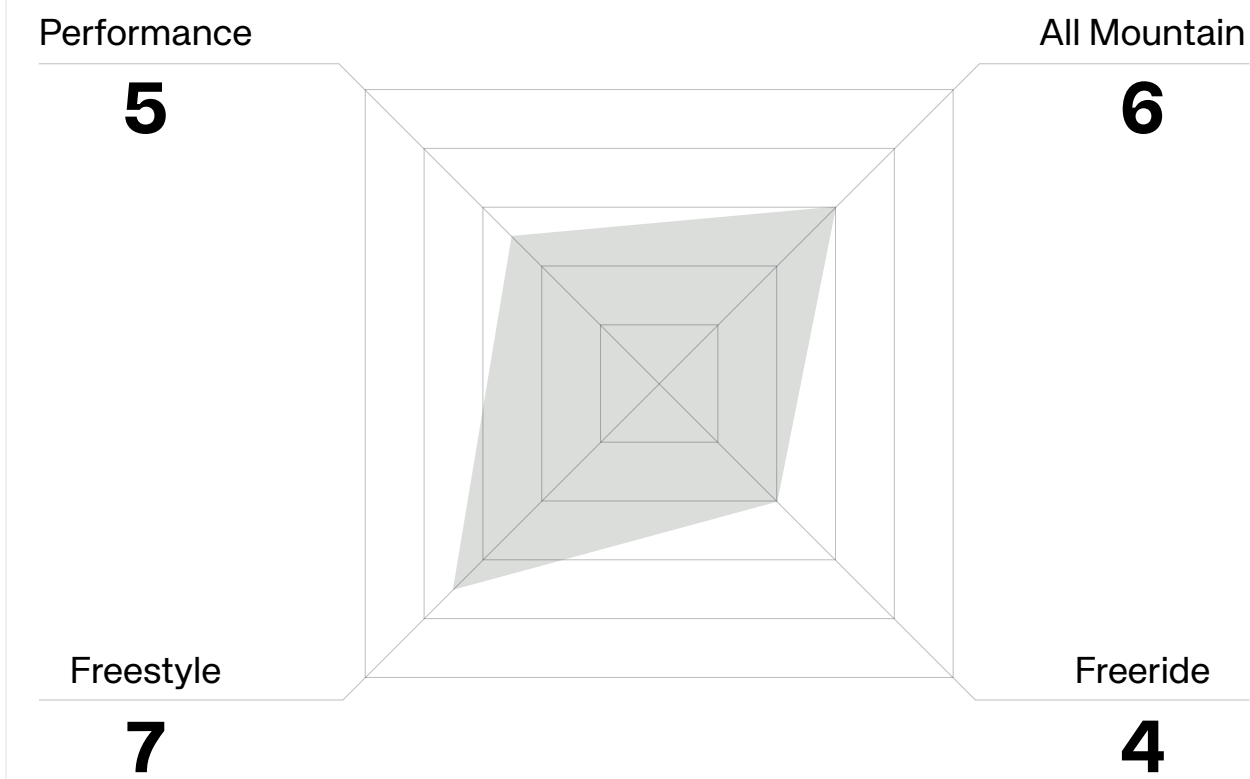

Binding Flex: 4/10



Technology

New

- BASEPLATE: S8 Duraflex
- BUSHING: Thermoformed EVA
- DISK COVER: Snap Fit
- CANTING: No
- HIGHBACK: CP3
- FLAD: Tool-Less
- HEELCUP: Extruded 3D Aluminum
- ANKLE STRAP: Exoframe 2.0
- TOE STRAP: TS 1.0 Hexgrip
- STRAP ADJUST: Traditional
- RATCHETS: Aluminum S2 w/Steel
- HARDWARE: Grade 8.8 Steel

Compatibility:

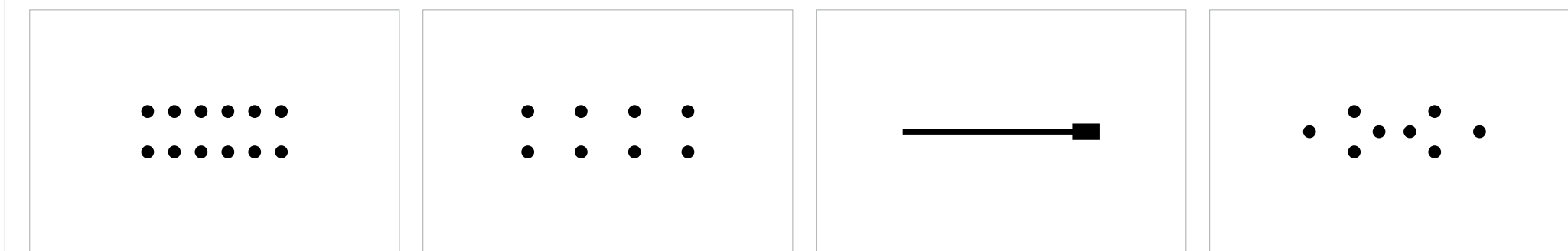

4x2

4x4

Channel

3D

Disk:



Universal Disk - V2





01.

Color: **Black**
Size: **S, M, L**



02.

Color: **Bone**
Size: **S, M, L**



03.

Color: **Blue**
Size: **S, M, L**



Angle: Back 3/4

Flite Pro

Colorways: 03 ● ● ●



Rosa / Women's Snowboard Binding



Product Description

Strap in to the lightest women's snowboard binding on the market. The Union Rosa is a lightweight, soft-flexing, freestyle snowboard binding for beginner to intermediate snowboarders. Perfect for learning to ride the entire mountain or taking your first park laps.

Key Features

- Upgraded Straps and Highback
- Budget Friendly
- Lightweight
- Compatible With All Mounting Systems

Weight: 630 grams

Binding Performance

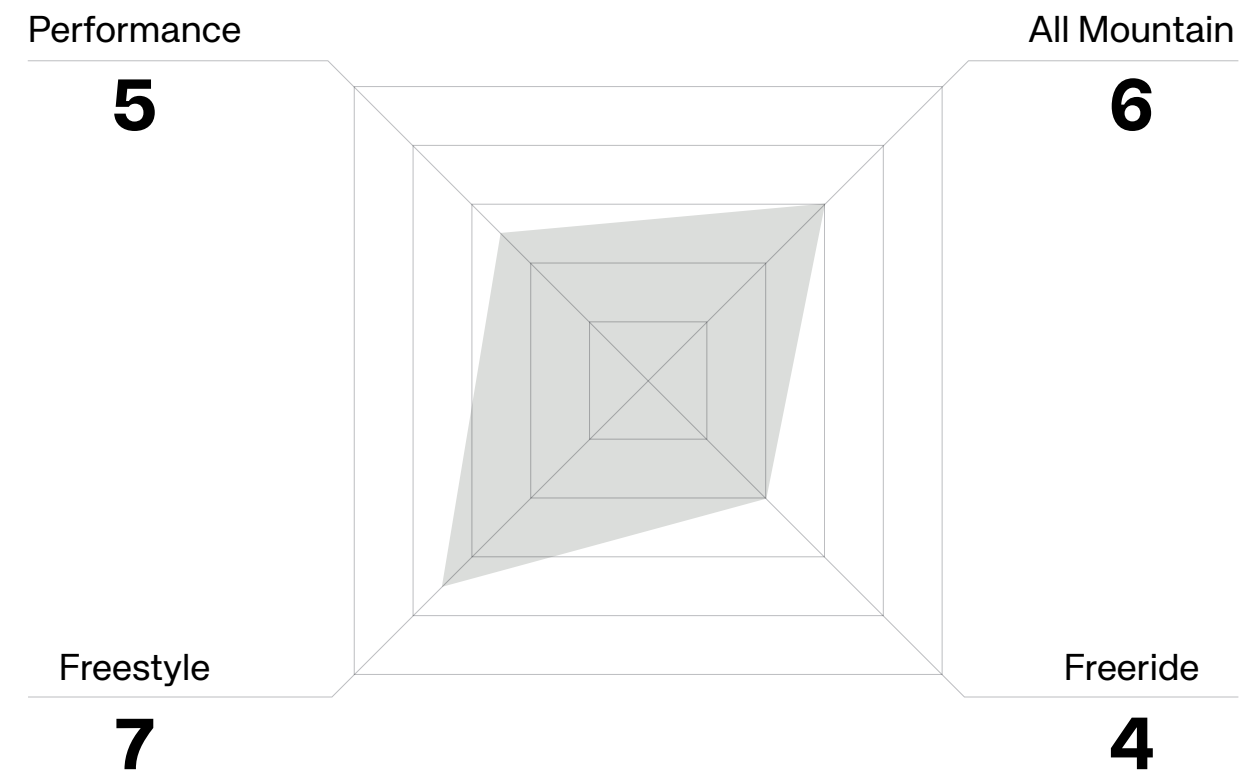

Binding Flex: 4/10



Compatibility:

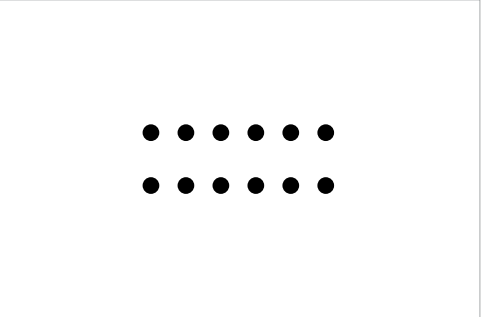

4x2

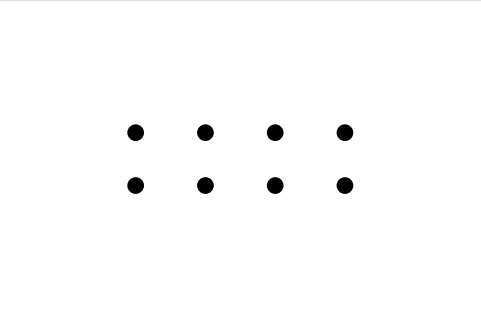

4x4

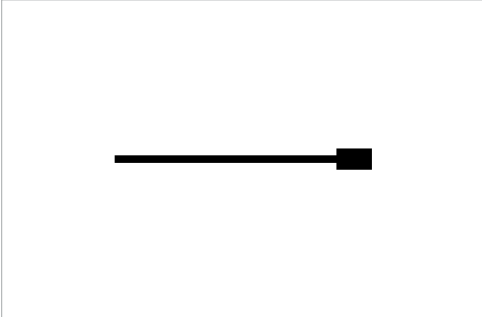

Channel

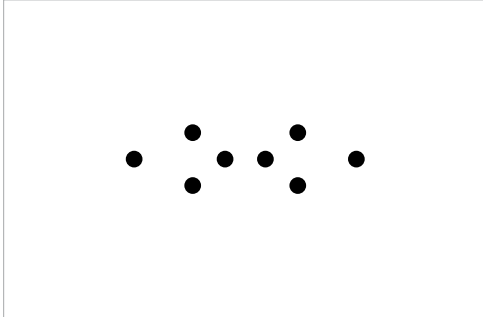

3D

Disk:



Universal Disk - V2

Technology

- | Technology | Value | New |
|---------------|----------------------|----------------------------------|
| BASEPLATE: | S8 Duraflex | <input type="radio"/> |
| BUSHING: | Thermoformed EVA | <input type="radio"/> |
| DISK COVER: | Snap Fit | <input type="radio"/> |
| CANTING: | No | <input type="radio"/> |
| HIGHBACK: | CP3 S | <input checked="" type="radio"/> |
| FLAD: | Tool-Less | <input type="radio"/> |
| HEELCUP: | Extruded 3D Aluminum | <input type="radio"/> |
| ANKLE STRAP: | Exoframe 2.0 | <input checked="" type="radio"/> |
| TOE STRAP: | TS 1.0 Hexgrip | <input checked="" type="radio"/> |
| STRAP ADJUST: | Traditional | <input type="radio"/> |
| RATCHETS: | Aluminum S2 w/Steel | <input checked="" type="radio"/> |
| HARDWARE: | Grade 8.8 Steel | <input type="radio"/> |





01.

Color: **Black**
Size: **S, M, L**



02.

Color: **Bone**
Size: **S, M, L**



03.

Color: **Pink**
Size: **S, M, L**



Angle: Back 3/4

Rosa

Colorways: 03 ● ● ●



Flite / Men's Snowboard Binding



Product Description

Everything you need and nothing you don't. The Union Flite snowboard binding is far from entry level and ready for any adventure that you can throw at it.

Key Features

- Durable Materials
- Budget Friendly
- Lightweight
- Compatible With All Mounting Systems

Weight: 670 grams

Binding Performance

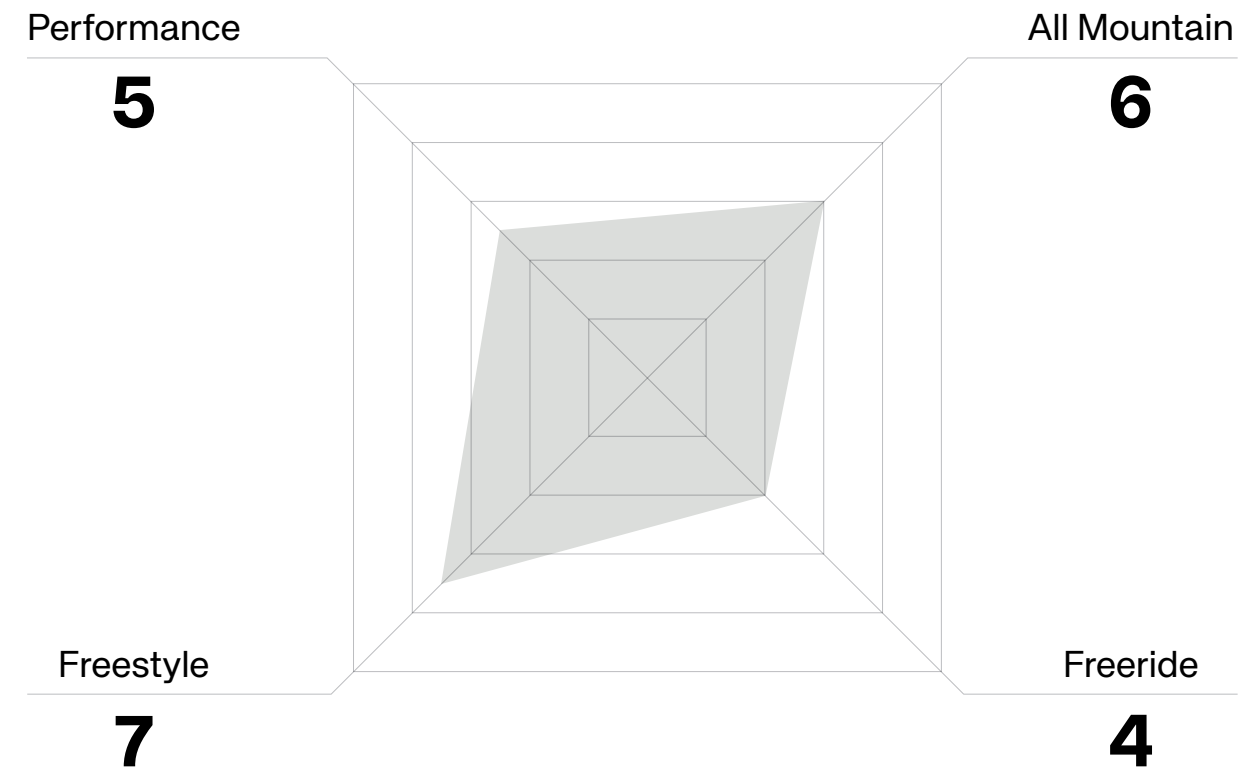

Binding Flex: 4/10



Technology

New

- BASEPLATE: S8 Duraflex
- BUSHING: Thermoformed EVA
- DISK COVER: Snap Fit
- CANTING: No
- HIGHBACK: S12 Flite Pro Duraflex
- FLAD: Tool-Less
- HEELCUP: Extruded 3D Aluminum
- ANKLE STRAP: Forma
- TOE STRAP: TS 4.0
- STRAP ADJUST: Traditional
- RATCHETS: Aluminum
- HARDWARE: Grade 8.8 Steel

Compatibility:

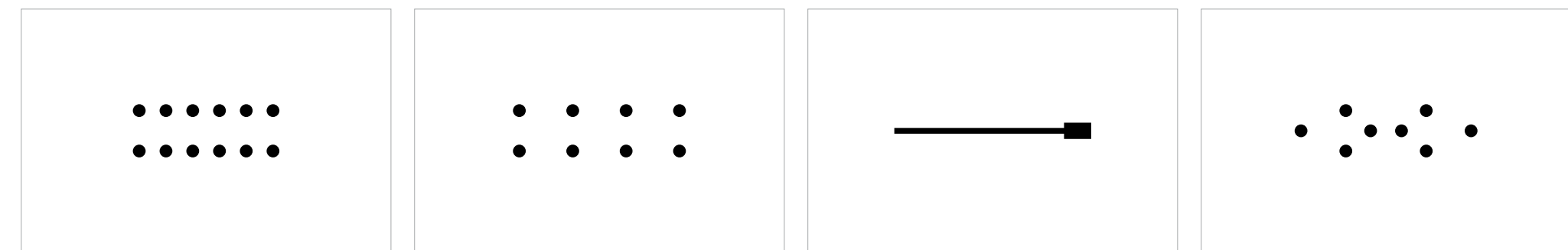

4x2

4x4

Channel

3D

Disk:



Universal Disk - V2



01.

Color: **Black**
Size: **XS, S, M, L**



Angle: Back 3/4

Flite

Colorways: 01 ●



Freestyle Overview

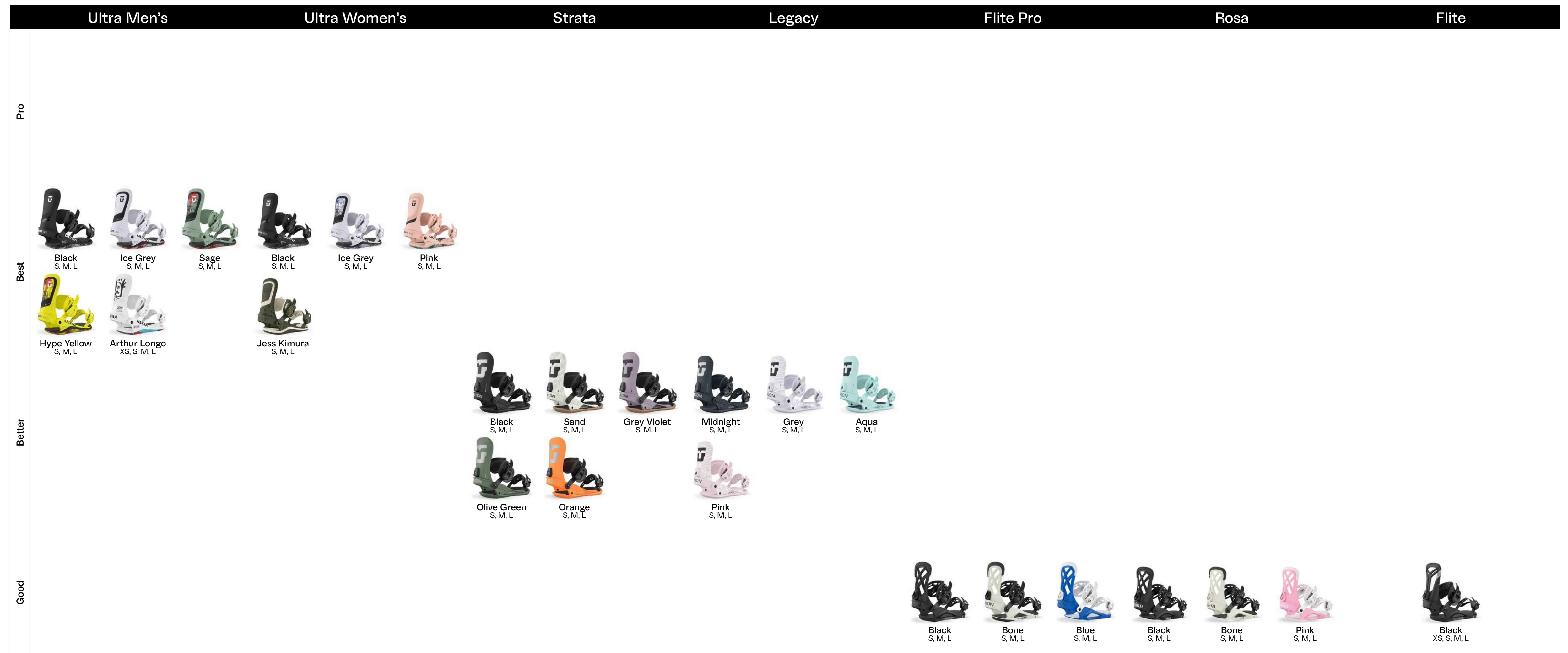

KIDS

TOUGH ENOUGH FOR KIDS

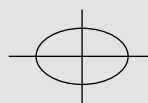
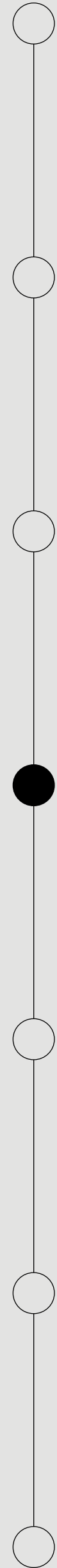
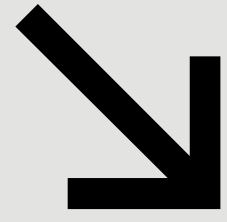

Rider: Oskar Rii | Photo: James North



Cadet Pro / Kids' Snowboard Binding



Product Description

A youth version of what the pros ride, the softer-flexing Cadet Pro is the best snowboard binding for kids and young teens looking to take their snowboarding to the next level. Comfortable, adjustable, and ready to ride any terrain on the mountain.

Key Features

Upgraded Technology

High Quality Materials

Marketed Model

Adjustable For Growing Feet

Weight: 770 grams

Binding Performance

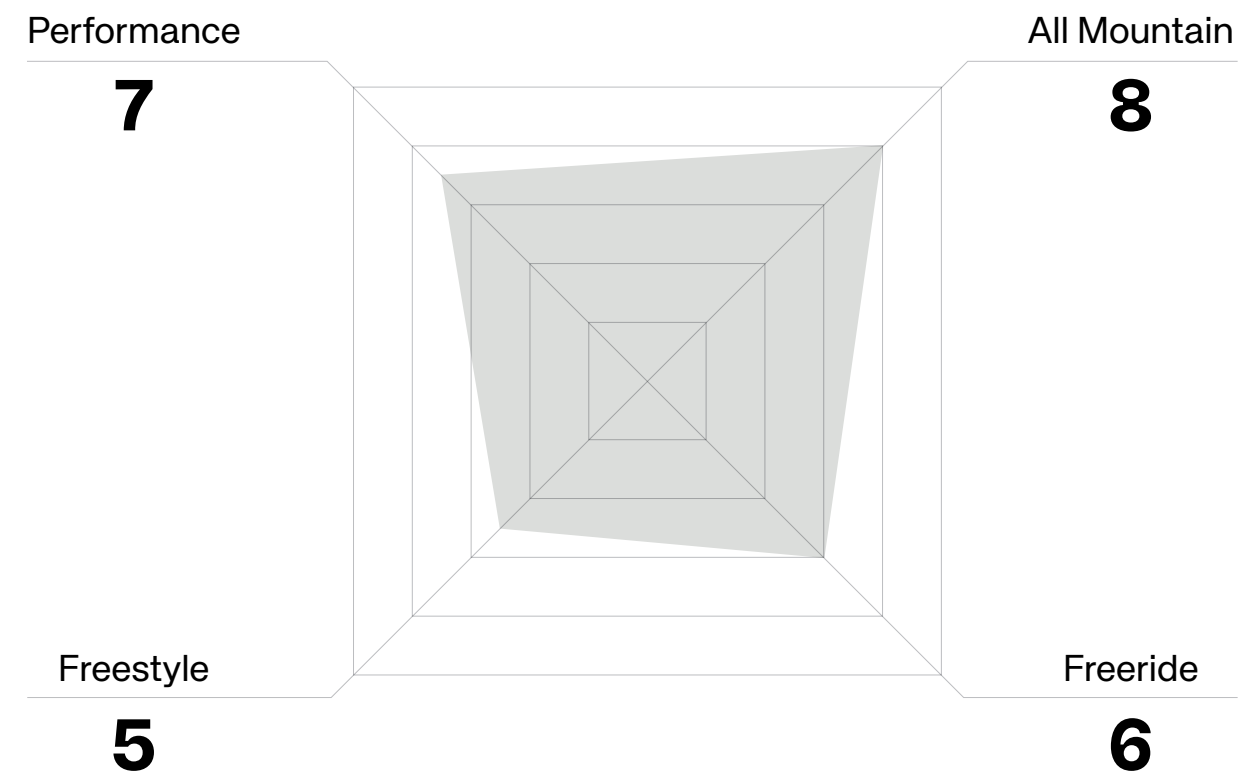

Binding Flex: 5/10



Compatibility:

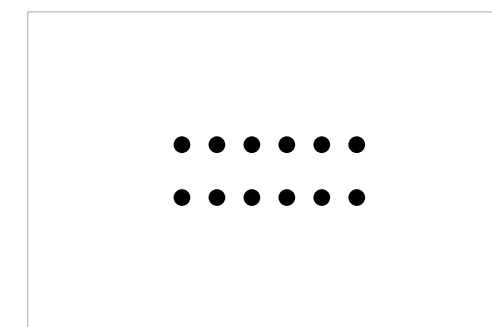

4x2

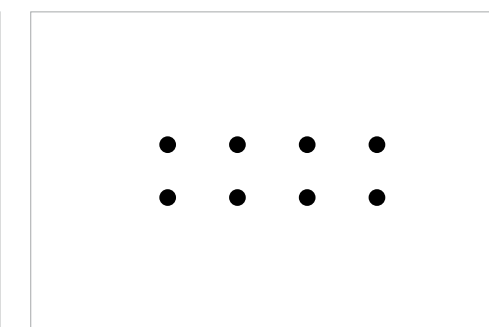

4X4

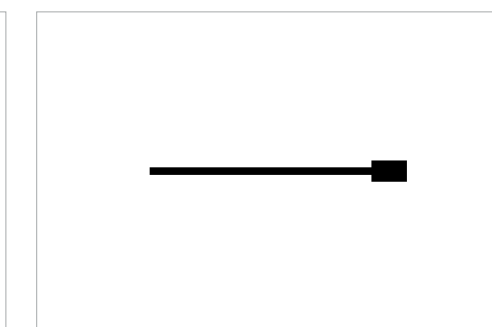

Channel

Disk:

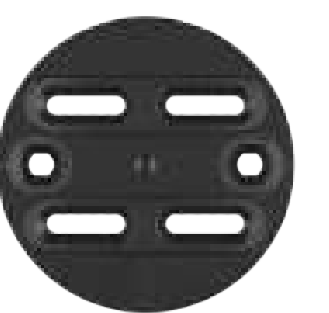

Camber Disk

Technology

New

- BASEPLATE: S5 Duraflex
- BUSHING: EXT Thermoformed EVA
- DISK COVER: Thermoformed EVA
- CANTING: Yes
- HIGHBACK: S19 S Duraflex
- FLAD: Tool-Less
- HEELCUP: Extruded 3D Aluminum
- ANKLE STRAP: Exoframe 3.0
- TOE STRAP: TS 2.1 Tiles
- STRAP ADJUST: Traditional
- RATCHETS: Aluminum S2 w/Steel
- HARDWARE: Grade 8.8 Steel





01.

Color: **Black**
Size: **S, M**



02.

Color: **Cyber Lime**
Size: **S, M**



Angle: Back 3/4

Cadet Pro

Colorways: 02 ● ●



Cadet / Kids' Snowboard Binding



Product Description

The best kids' snowboard binding on the market, hands down. The Union Cadet is comfortable, adjustable and ready for young snowboarders of all ability levels and riding styles. Made for kids that want to shred the entire mountain and more.

Key Features

- High Quality Materials
- Adjustable Straps
- Adjustable Heelcup
- Compatible With All Mounting Systems

Weight: 640 grams

Binding Performance

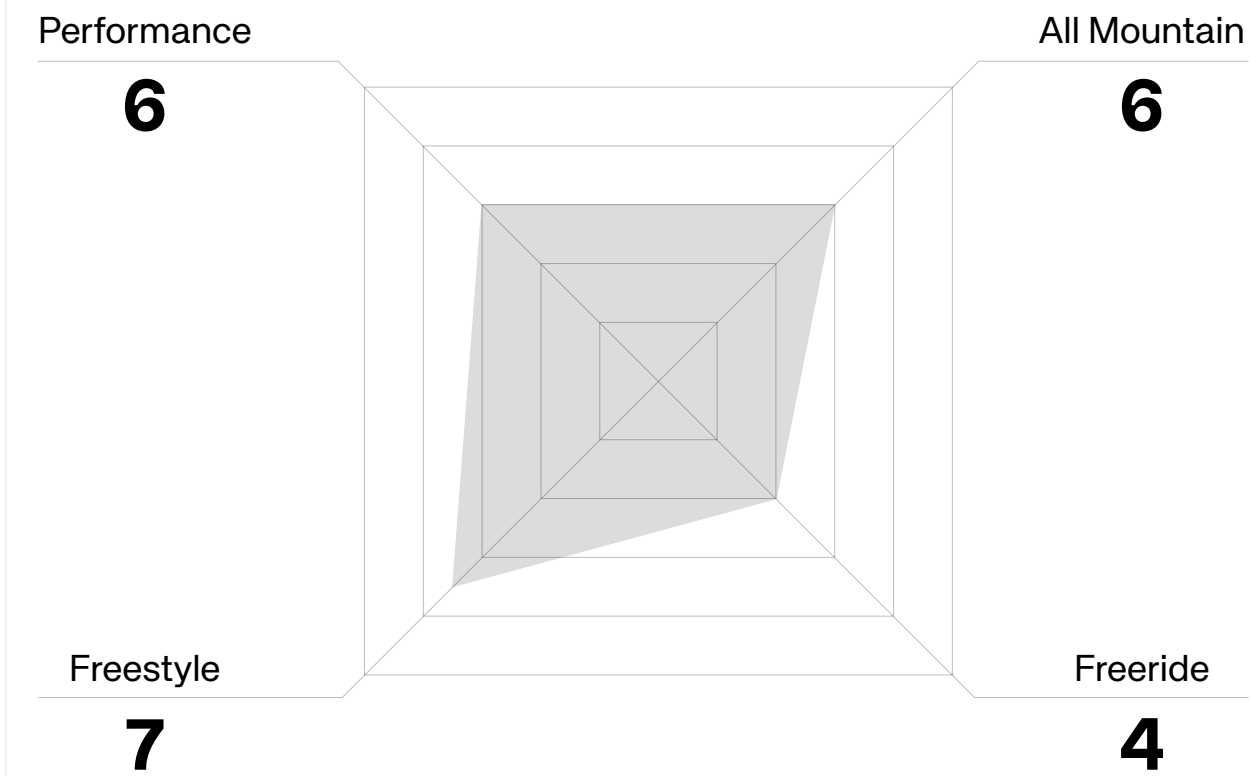

Binding Flex: 4/10

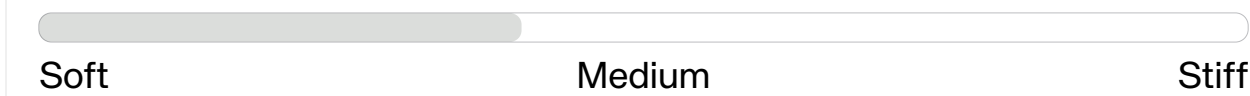

Technology

New

- BASEPLATE: S8 Duraflex
- BUSHING: Thermoformed EVA
- DISK COVER: Snap Fit
- CANTING: No
- HIGHBACK: Cadet Duraflex
- FLAD: Tool-Less
- HEELCUP: Extruded 3D Aluminum
- ANKLE STRAP: Exoframe 2.0
- TOE STRAP: TS 2.1 Hexgrip
- STRAP ADJUST: Traditional
- RATCHETS: Aluminum S2 w/Steel
- HARDWARE: Grade 8.8 Steel

Compatibility:

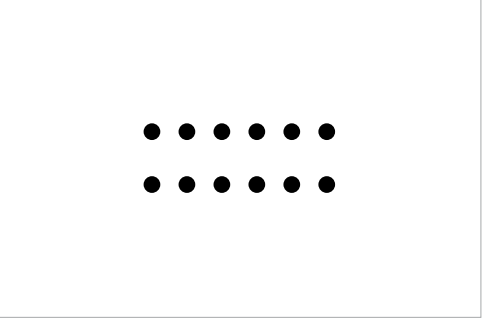

4x2

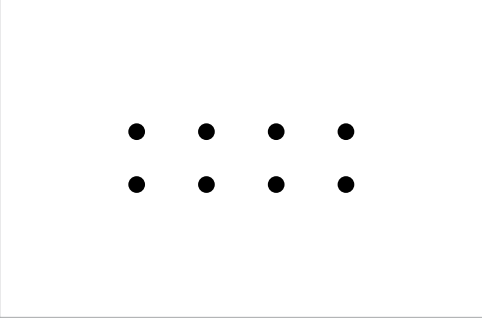

4x4

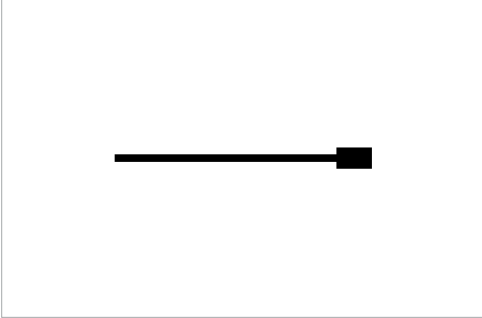

Channel

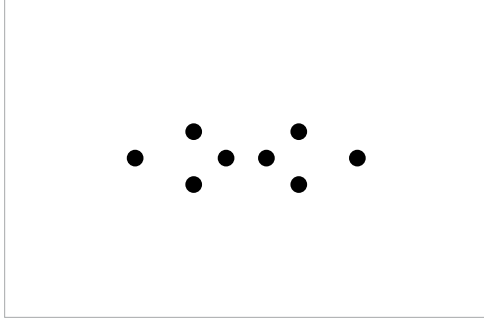

3D

Disk:



Universal Disk - V2





01.

Color: **Black**
Size: **S, M**



02.

Color: **Purple**
Size: **S, M**



Angle: Back 3/4

Cadet

Colorways: 02 ● ●



Cadet Mini / Kids' Snowboard Binding



Product Description

A performance snowboard binding, built specifically for younger kids. The Cadet Mini packs more performance features than any other kids' binding on the market today. Comfortable, easy to use and adjusts with growing feet. Compatible with all mounting systems and comes packaged in an insulated kids' lunch box.

Weight: 550 grams

Binding Performance

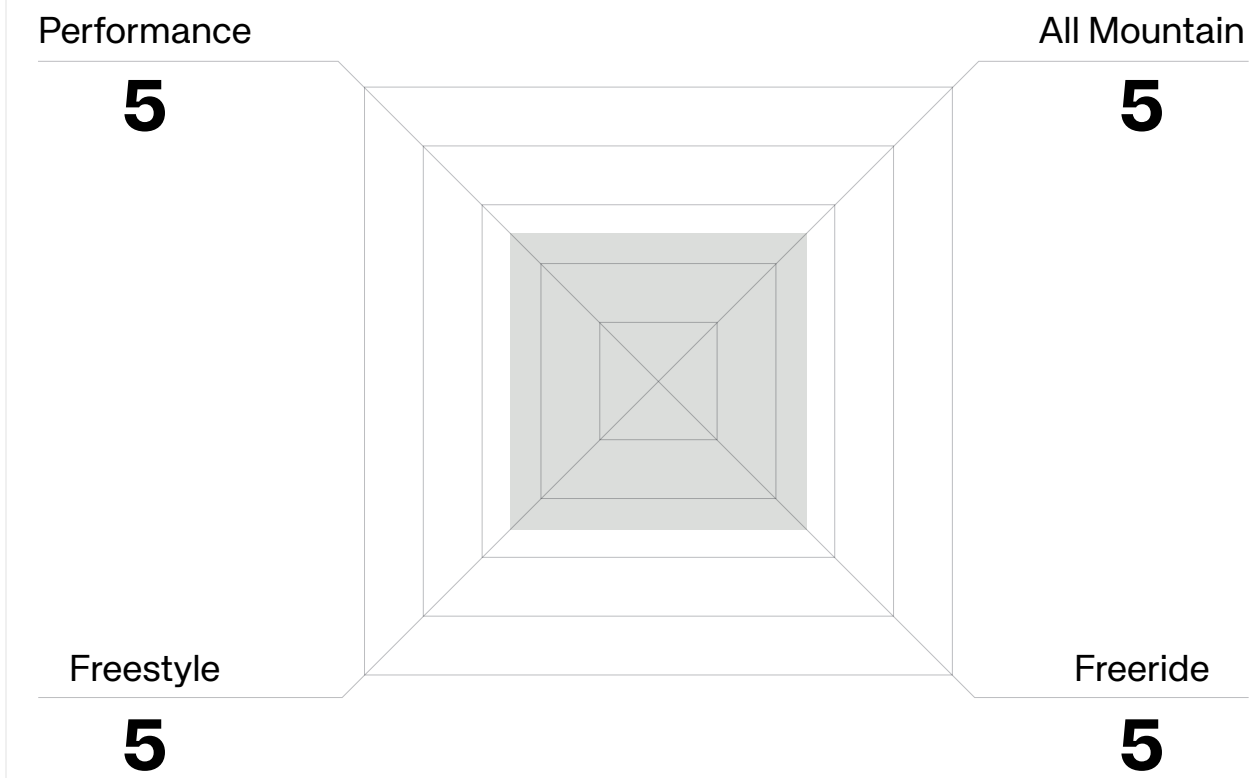

Binding Flex: 3/10

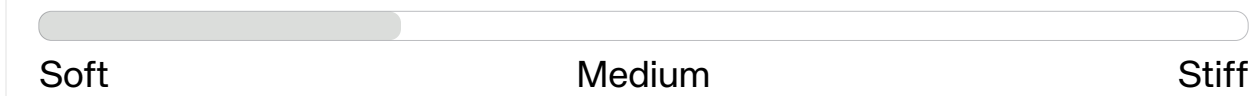

Compatibility:

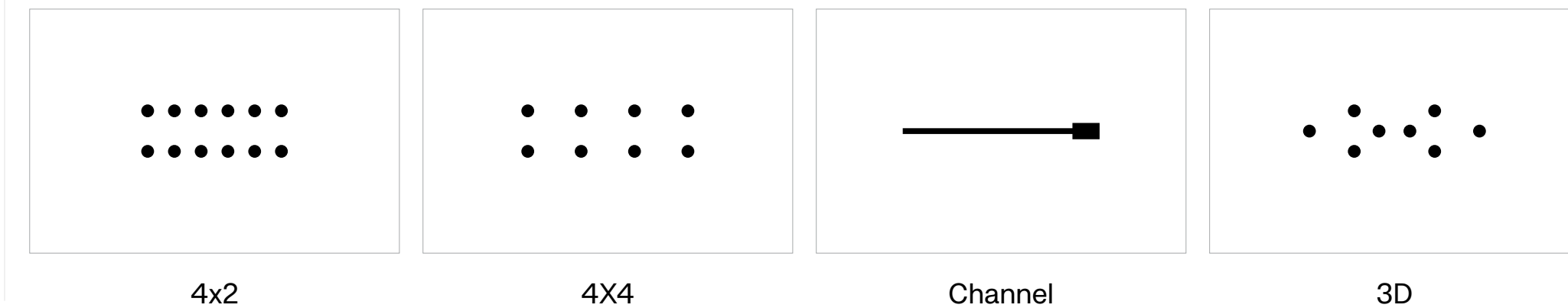

Key Features

- High Quality Materials
- Adjustable Straps
- 5-Way Adjustable Heelcup
- Compatible With All Mounting Systems

Technology

Technology	Value	New
BASEPLATE:	S5 Mini Duraflex	<input type="radio"/>
BUSHING:	EXT Thermoformed EVA	<input type="radio"/>
DISK COVER:	No	<input type="radio"/>
CANTING:	No	<input type="radio"/>
HIGHBACK:	Cadet XS Duraflex	<input type="radio"/>
FLAD:	Tool-Less	<input type="radio"/>
HEELCUP:	Extruded 3D Aluminum	<input type="radio"/>
ANKLE STRAP:	Forma XS	<input type="radio"/>
TOE STRAP:	TS 2.1 Ultragrip	<input checked="" type="radio"/>
STRAP ADJUST:	Traditional	<input type="radio"/>
RATCHETS:	Aluminum S2 w/Steel	<input checked="" type="radio"/>
HARDWARE:	Grade 8.8 Steel	<input type="radio"/>

Disk:



Universal Disk - V2





Color: **Black**
Size: **Mini**



Color: **Blue**
Size: **Mini**



Angle: Back 3/4

Cadet Mini

Colorways: 02 ●●



Cadet One / Kids' Snowboard Binding



Product Description

What is this? A binding for ants? No, this is the Cadet One kids' snowboard binding. Union's smallest binding offering of all time. Perfect for your little one's first time strapping in at the mountain or in the living room.

Key Features

Union's Smallest Binding Offering

Single Strap Design

Easy to Use

Fits Boot Sizes: 7C - 11C

Weight: 320 grams

Binding Performance

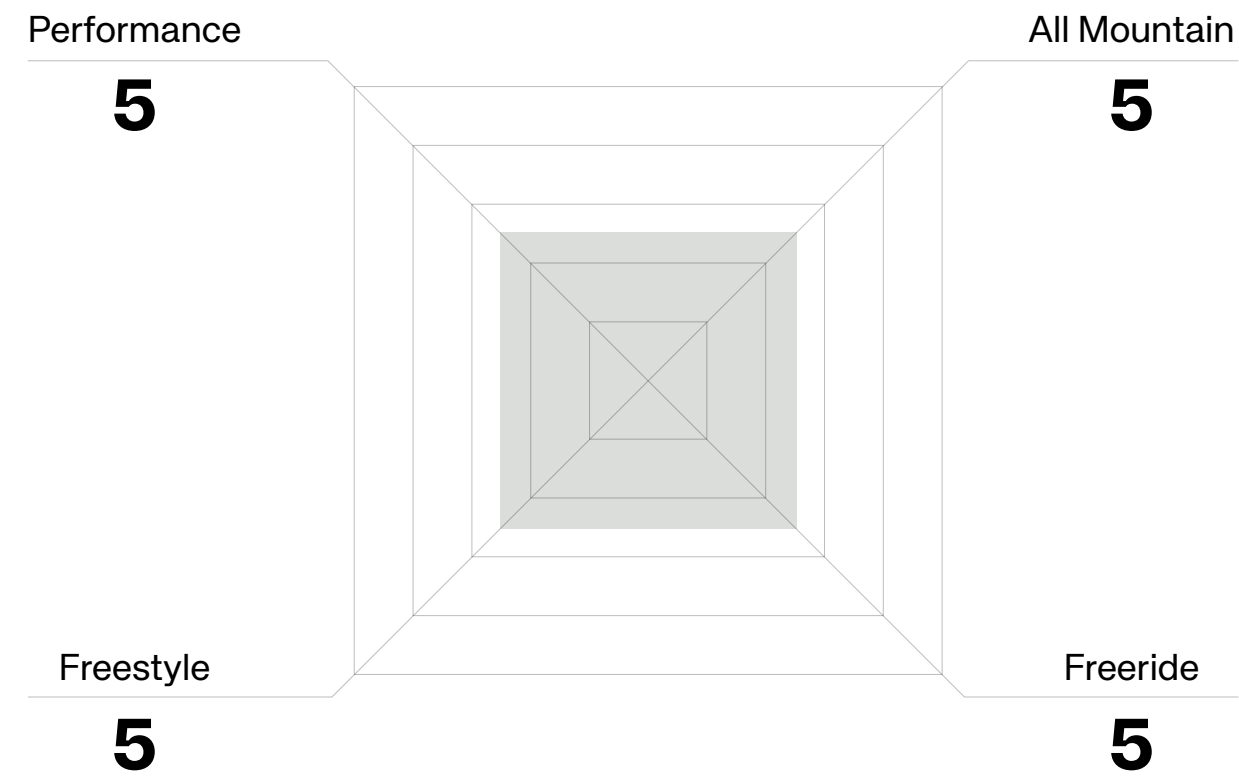

Binding Flex: 3/10

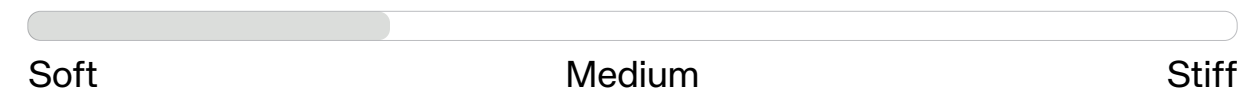

Compatibility:

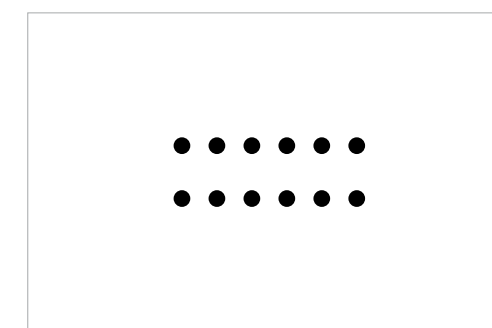

4x2

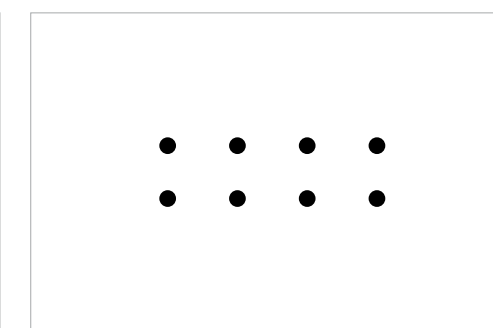

4x4

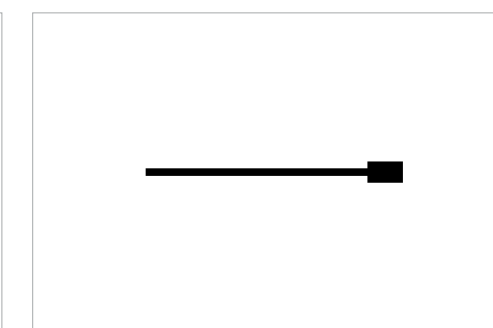

Channel

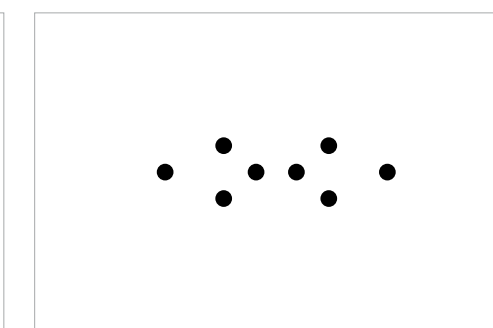

3D

Disk:



Universal Disk - V2

Technology

New

- BASEPLATE: C1 Duraflex
- HIGHBACK: C1 Duraflex
- HEELCUP: Extruded 3D Aluminum
- STRAP: Single Strap System
- STRAP ADJUST: Traditional
- RATCHETS: Aluminum S2 w/Steel
- HARDWARE: Grade 8.8 Steel





Color: **White**
Size: **One**



Cadet One

Colorways: 01

Kids Overview

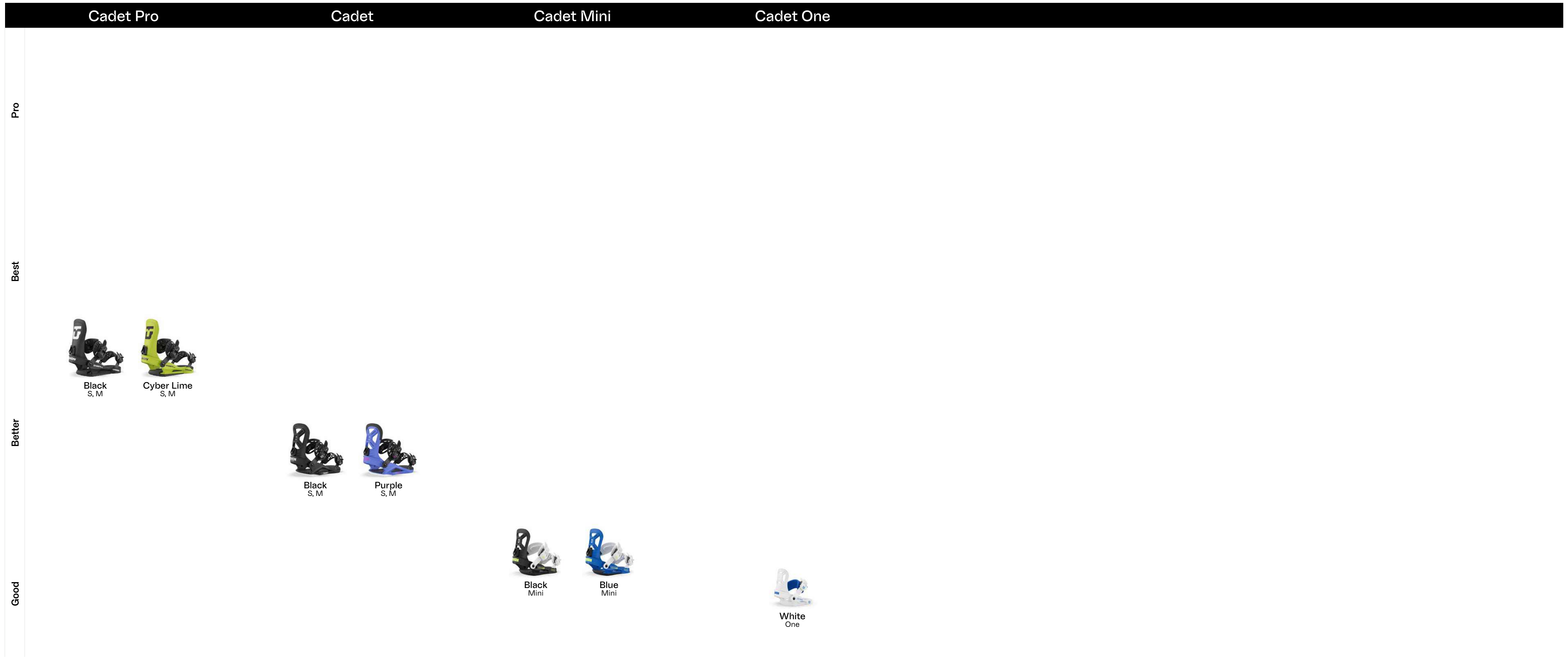

EXPEDITION

BUILT FOR SNOWBOARDERS

BACKCOUNTRY TOOLS

EASY TO USE

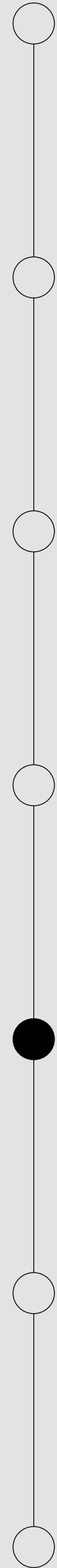
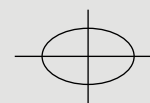
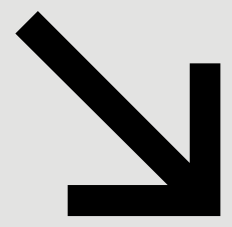

Rider: Bryan Iguchi | Photo: Keegan Rice



Charger Pro / Unisex Splitboard Binding



Product Description

The ultimate performance-driven splitboard binding. The Union Charger Pro combines the perfect blend of stiffness for the tour up and flex for the ride down. Tested, trusted and designed with the help of professional splitboarder, Forrest Shearer.

Weight: 795 grams

Binding Performance

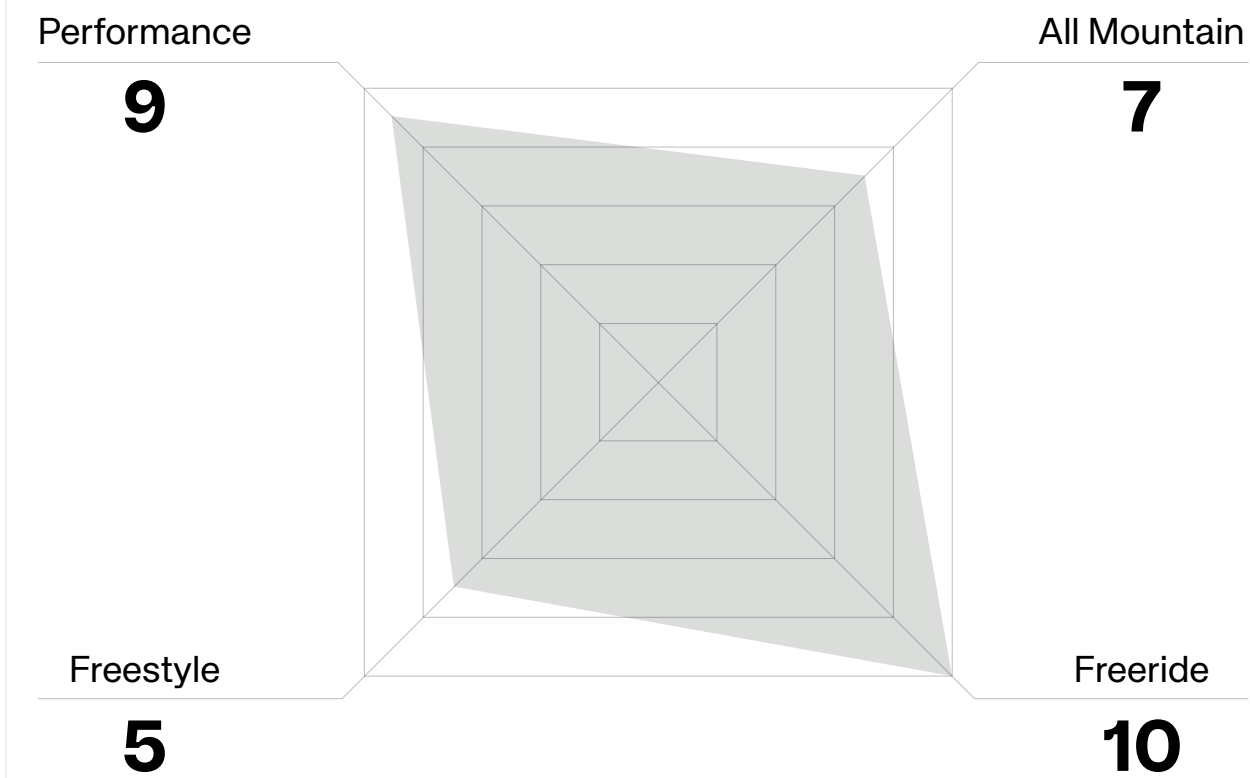

Binding Flex: 8/10



Compatibility:

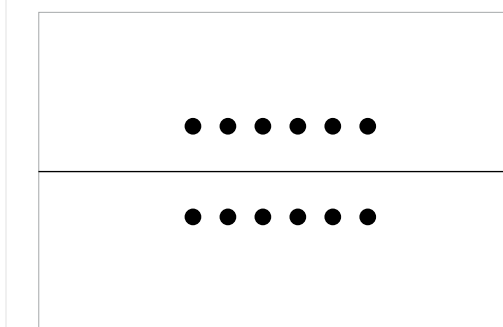

Voile (Split Disk)

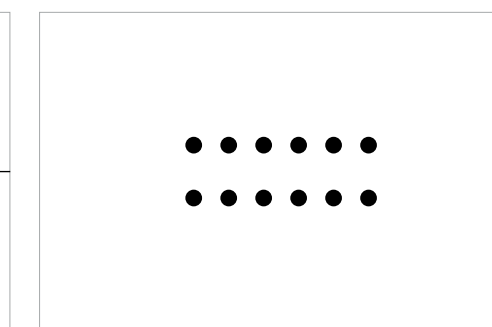

4x2 (Quiver Disk Only)

Key Features

- Pinless Transitions
- Technical Updates on Touring Hardware
- Includes All Necessary Hardware
- Ridden By: Bryan Iguchi and Forrest Shearer

Technology

Technology	Value	New
BASEPLATE:	EXP3 Durafelx CB	<input type="checkbox"/>
BUSHING:	Hot Press EVA	<input type="checkbox"/>
GAS PEDAL:	Non-Stick EVA	<input type="checkbox"/>
CANTING:	No	<input type="checkbox"/>
HIGHBACK:	EXP4 Duraflex ST	<input type="checkbox"/>
FLAD:	Dino Flad	<input type="checkbox"/>
HEELCUP:	Forged Carbon	<input type="checkbox"/>
ANKLE STRAP:	Exoframe 5.0	<input type="checkbox"/>
TOE STRAP:	TS 4.0+	<input type="checkbox"/>
STRAP ADJUST:	Tool-Less	<input type="checkbox"/>
RATCHETS:	Magnesium S1 w/Aluminum Base	<input type="checkbox"/>
HARDWARE:	Grade 8.8 Steel	<input type="checkbox"/>
CLIMBING BAR:	Integrated	<input type="checkbox"/>

Disk:

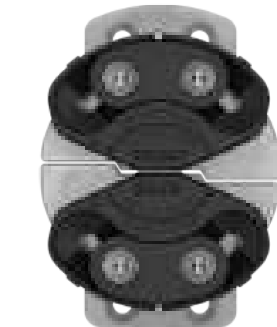

Charger Split Disk

Touring Bracket:



Charger Touring Bracket





01.

Color: **Black**
Size: **M, L**

🔗 Carry Forward



Angle: Back 3/4

Charger Pro

Colorways: 01 ●



Charger / Unisex Splitboard Binding



Product Description

Quick and easy transitions with the flip of a lever. The Union Charger splitboard binding has quickly become a fan favorite of splitboarders and snowboarders around the globe. Durable, easy to use, and the best ride feel of any binding on the market today. Make the switch to Union splitboard bindings and finally enjoy the ride down.

Weight: 830 grams

Binding Performance

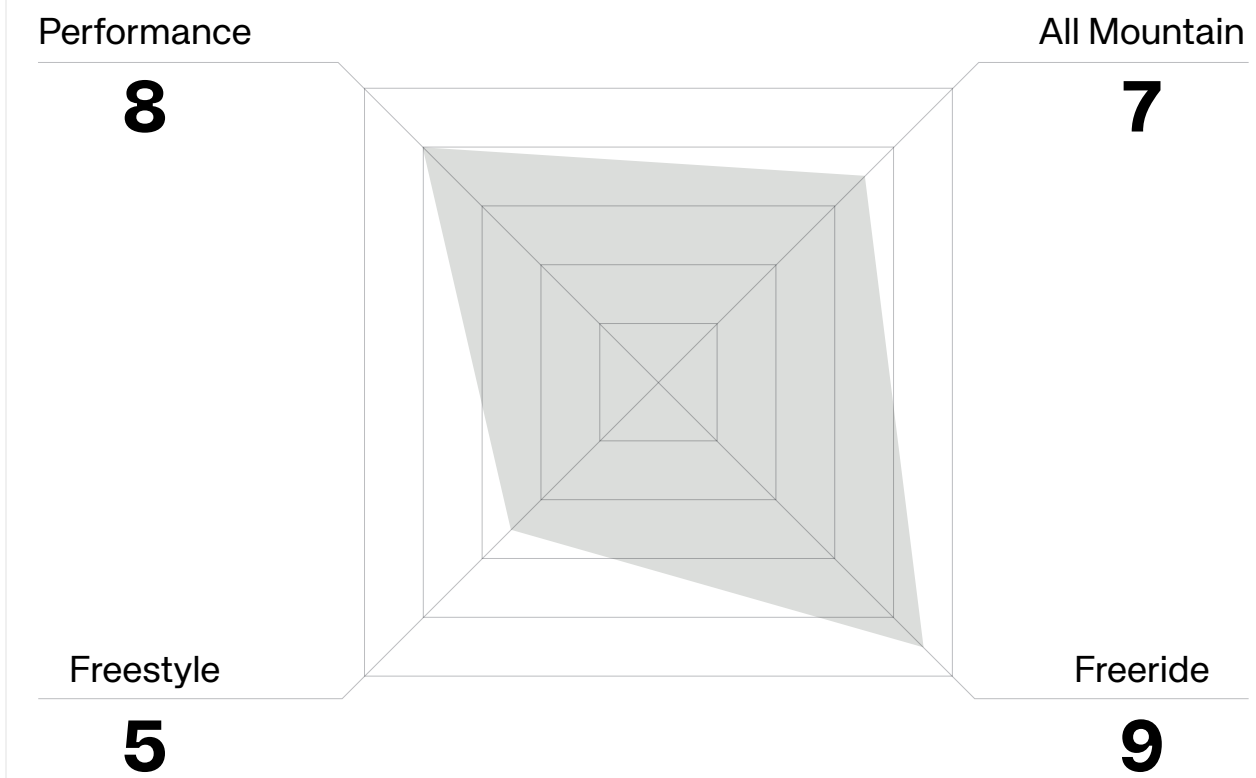

Binding Flex: 7/10

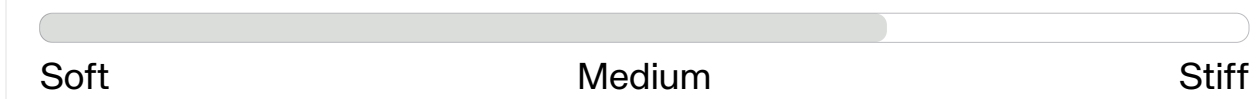

Compatibility:

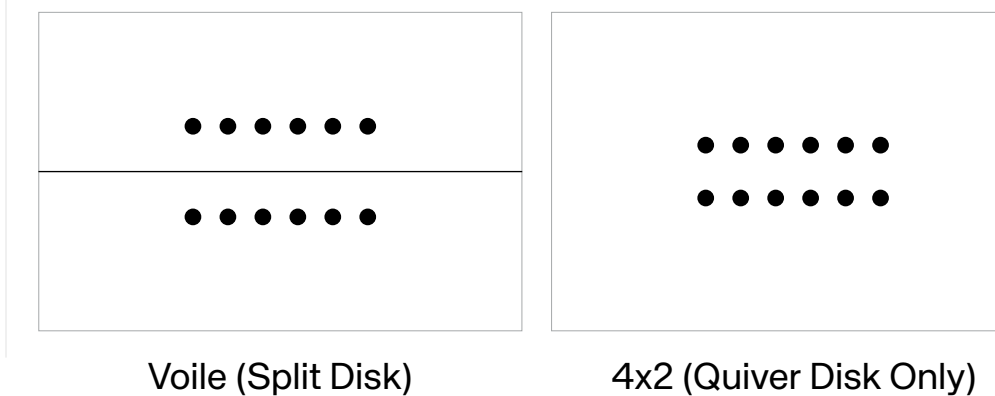

Key Features

- Pinless Transitions
- Natural Board Feel
- Technical Updates on Touring Hardware
- Includes All Necessary Hardware

Technology

- BASEPLATE: EXP3 Duraflex CB
- BUSHING: Hot Press EVA
- GAS PEDAL: Non-Stick EVA
- CANTING: No
- HIGHBACK: EXP3 Duraflex
- FLAD: Dino Flad
- HEELCUP: Extruded 3D Aluminum w/Astro Washer
- ANKLE STRAP: Exoframe 5.0
- TOE STRAP: TS 4.0+
- STRAP ADJUST: Tool-Less
- RATCHETS: Magnesium S1 w/Aluminum Base
- HARDWARE: Grade 8.8 Steel
- CLIMBING BAR: Integrated

Disk:



Charger Split Disk

Touring Bracket:



Charger Touring Bracket





01.

Color: **Black**
Size: **S, M, L**

👉 Carry Forward



Angle: Back 3/4

Charger

Colorways: 01 ●



Explorer / Unisex Splitboard Binding



Product Description

When your splitboard bindings ride like your regular bindings, it's easy to enjoy the ride down. The Union Explorer is a splitboard binding for beginner to intermediate splitboarders, that focuses on natural board feel, less moving parts, and a durable design built to handle the longest tours and steepest lines.

Weight: 810 grams

Binding Performance

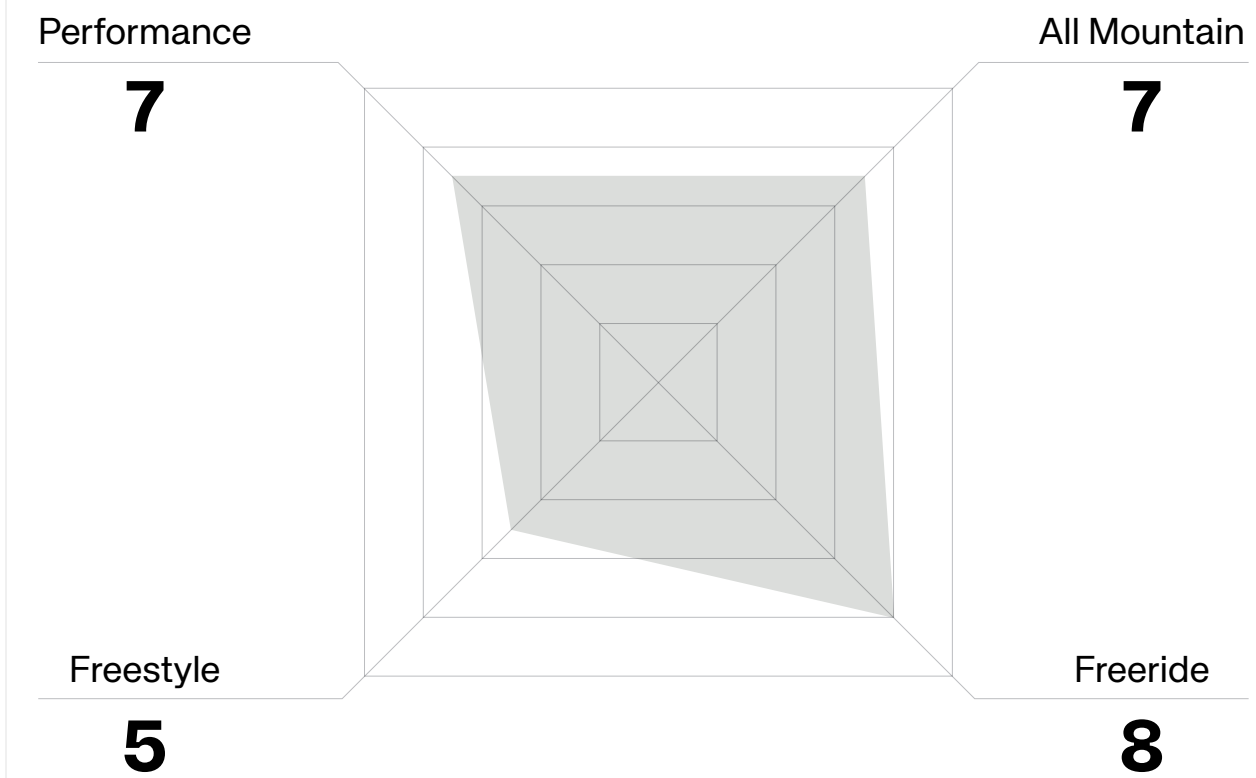

Binding Flex: 6/10

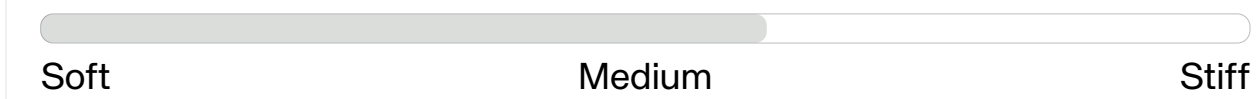

Compatibility:

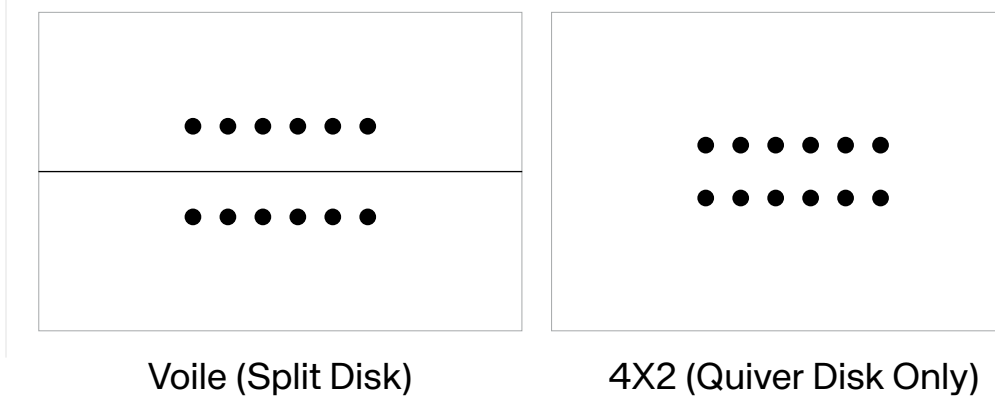

Key Features

- Durable
- Easy to Use
- Natural Board Feel
- Includes All Necessary Hardware

Technology

Technology	Value	New
BASEPLATE:	EXP2 Duraflex ST	<input type="checkbox"/>
BUSHING:	Hot Press EVA	<input type="checkbox"/>
GAS PEDAL:	Non-Stick EVA	<input type="checkbox"/>
CANTING:	No	<input type="checkbox"/>
HIGHBACK:	EXP2 Duraflex	<input type="checkbox"/>
FLAD:	Split Flad 2.0	<input type="checkbox"/>
HEELCUP:	Extruded 3D Aluminum	<input type="checkbox"/>
ANKLE STRAP:	Exoframe 4.0	<input type="checkbox"/>
TOE STRAP:	TS 2.0 W/Pin	<input type="checkbox"/>
STRAP ADJUST:	Tool-Less	<input type="checkbox"/>
RATCHETS:	Magnesium 3.0 w/Aluminum Base	<input type="checkbox"/>
HARDWARE:	Titanium + Grade 8.8 Steel	<input type="checkbox"/>
CLIMBING BAR:	Integrated	<input type="checkbox"/>

Disk:



Explorer Split Disk

Touring Bracket:



Explorer Touring Bracket





01.

Color: **Black**
Size: **S, M, L**

👉 Carry Forward



Angle: Back 3/4

Explorer

Colorways: 01 ●



Expedition Overview

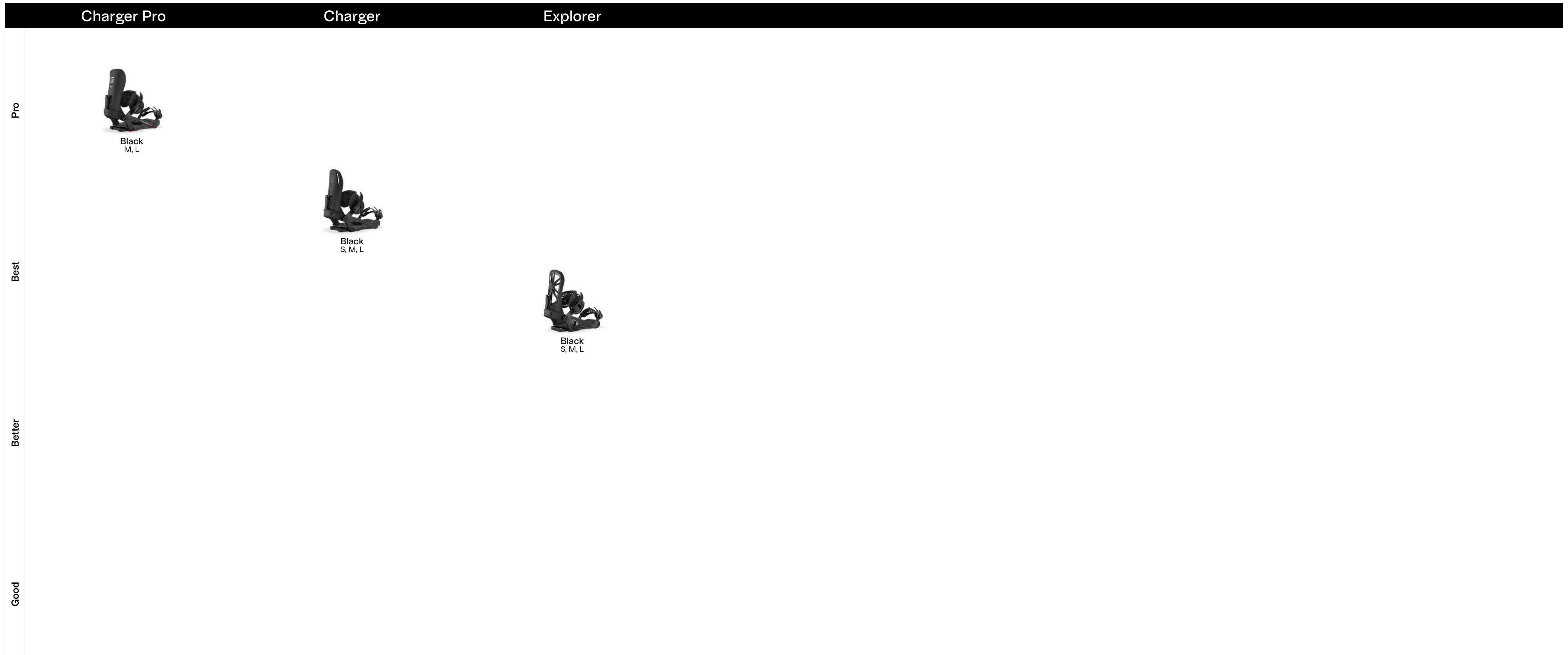

RENTAL

RELIABLE

BOMBPROOF

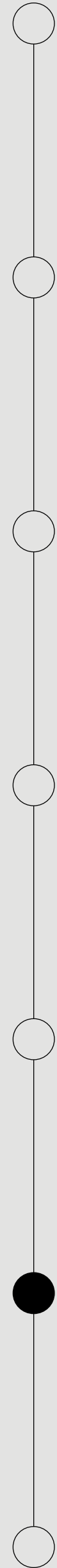
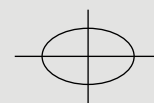
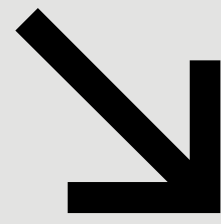

Riders: Joey Fava + Benny Milam | Photo: Matt Roebke



Rental / Rental Snowboard Binding



Product Description

Easily adjustable components, durable materials and our trusted after-sales service make Union rental bindings the new choice to get all levels of riders started off on the right foot and coming back for more.

Weight: 635 grams

Binding Performance

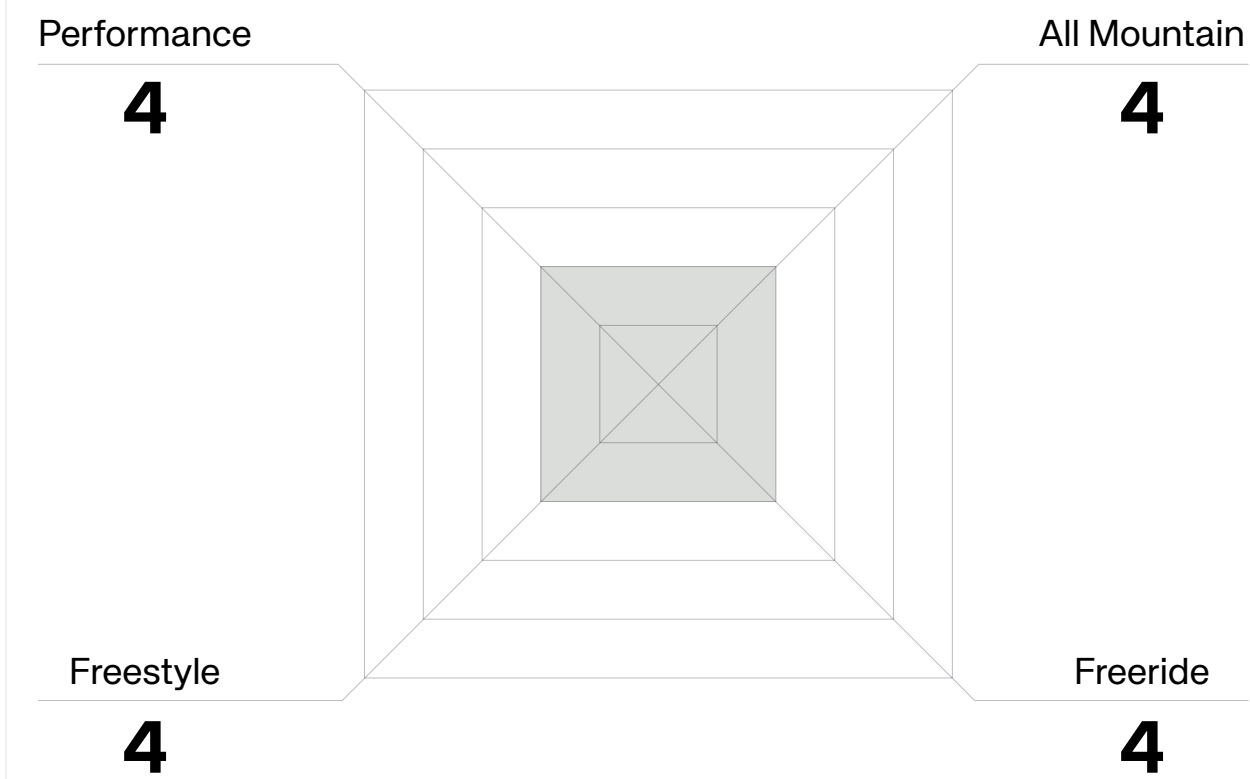

Binding Flex: 5/10



Compatibility:

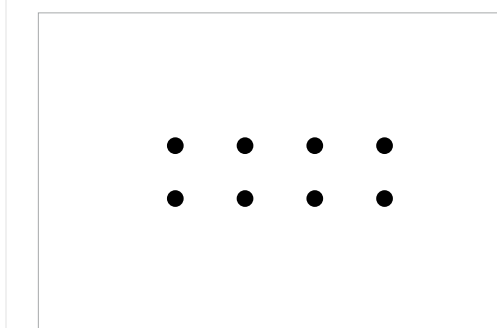

4X4

Key Features

- Reliable
- Bombproof
- Optimized for Rental
- Easy to Use

Technology

New

BASEPLATE:	Rental Duraflex ST	<input type="checkbox"/>
BUSHING:	N/A	<input type="checkbox"/>
DISK COVER:	N/A	<input type="checkbox"/>
CANTING:	N/A	<input type="checkbox"/>
HIGHBACK:	Rental Duraflex ST	<input type="checkbox"/>
FLAD:	Rental EZ-Flip	<input type="checkbox"/>
HEELCUP:	Extruded 3D Aluminum	<input type="checkbox"/>
ANKLE STRAP:	Exo Rental	<input type="checkbox"/>
TOE STRAP:	TS Rental	<input type="checkbox"/>
STRAP ADJUST:	Cam Quick Adjust	<input type="checkbox"/>
RATCHETS:	Aluminum	<input type="checkbox"/>
HARDWARE:	Grade 8.8 Steel	<input type="checkbox"/>

Disk:



Rental Disk

RENTAL → TECHNOLOGY OVERVIEW

1 EASY FLIP FLAD



One click adjustment. High and low setting. Easy to use with gloves on.

2 FIXED ANKLE HARDWARE



Impossible to lose. Prevents customers from being able to lose straps while riding.

3 HEELCUP ADJUSTER



Easy to use. Five available heelcup positions. Two binding sizes cover all boot sizes.

4 QUICK CAM ADJUSTER



Easy to adjust. Impossible to lose. Ample range of adjustment for all boot brands, models and sizes.

5 RENTAL DISK



Quickly mount and unmount bindings with the Union easy-lock disk system. Disk stays on the board, bindings come off for efficient storage.

6 RENTAL SIZES



Orange HB = S. | Black HB = M/L. Two binding sizes cover all boot sizes

7 RENTAL STRAPS



Simple, durable, color-coded, and labeled for beginner riders.

8 WIDE FIT BASEPLATE



Wider fit for bulky rental boots. Built with extremely durable Duraflex ST Nylon. No paint for increased durability.



01.

Color: **Black / Orange**  Carry Forward
Size: **S/M**



02.

Color: **Black / Black**  Carry Forward
Size: **M/L**



Angle: Back 3/4

Rental

Colorways: 02  

ACCESSORIES

APPAREL & BAGS

TOOLS

REPLACEMENT PARTS

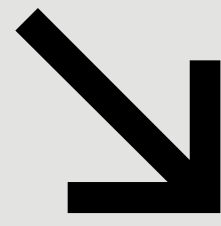
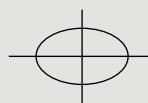

Rider: Andrea Gualtieri | Photo: Funky Studios



Softgoods and Headwear

Logo Tee Shirt

Size: S, M, L, XL, XXL
Color: ● ○

* New



Throwback LS Tee

Size: S, M, L, XL, XXL
Color: ●

* New



DDC LS Tee

Size: S, M, L, XL, XXL
Color: ●

* New



DDC LS Tee

Size: S, M, L, XL, XXL
Color: ○

* New



DDC LS Tee

Size: S, M, L, XL, XXL
Color: ●

* New



Premium Crew Neck

Size: S, M, L, XL, XXL
Color: ●

👉 Carry Forward



Team Hoodie

Size: S, M, L, XL, XXL
Color: ●

👉 Carry Forward



Team Hoodie

Size: S, M, L, XL, XXL
Color: ●

👉 Carry Forward



Team Hoodie

Size: S, M, L, XL, XXL
Color: ●

* New



Team Hoodie

Size: S, M, L, XL, XXL
Color: ●

* New



Softgoods and Headwear

20-YR LS Tee

Size: S, M, L, XL, XXL
Color: ●

✳ New



20-YR Zip Hoodie

Size: S, M, L, XL, XXL
Color: ●

✳ New



20-YR Cap

Size: OSFM
Color: ●

✳ New



20-YR Beanie

Size: OSFM
Color: ●

✳ New



20-YR Beanie

Size: OSFM
Color: ○

✳ New



Shop Apron

Size: OSFM
Color: ●

👉 Carry Forward



Softgoods and Headwear

Icon Cap

Size: OSFM
Color: ●

* New



Icon Cap

Size: OSFM
Color: ○

* New



Moto Cap

Size: OSFM
Color: ●

* New



Moto Cap

Size: OSFM
Color: ○

* New



UBC Beanie

Size: OSFM
Color: ●

* New



UBC Beanie

Size: OSFM
Color: ●

* New



Team Cuffless Beanie

Size: OSFM
Color: ●

* New



Team Cuffless Beanie

Size: OSFM
Color: ●

* New



Team Cuffless Beanie

Size: OSFM
Color: ●

* New



Bags

Expedition Pack 24L

Size: 24L
Color: ●

👉 Carry Forward

TECHNICAL SPECIFICATIONS:

- Materials: 100% Recycled Polyester
- Vertical Board Carry
- Horizontal Board Carry
- A-Frame Splitboard Carry
- Side Vertical Approach Ski Carry
- Back Access
- Oversized Fleece Lined Goggle Pocket
- Avalanche Safety Tool Pocket
- Waist Belt Pocket
- Waist Belt Crampon Attachment
- Insulated Hydration Shoulder Strap
- Internal Mesh Hydration Sleeve with Hanger
- Internal Mesh Accessory Pocket
- Durable 38mm Webbing
- Multi Functional Daisy Web Details on Bag / Shoulder Straps



Resort Pack 14L

Size: 14L
Color: ● ●

👉 Carry Forward

TECHNICAL SPECIFICATIONS:

- Materials: 100% Recycled Polyester
- Vertical Board Carry
- Oversized Fleece Lined Goggle Pocket
- Avalanche Safety Tool Pocket
- Waist Belt
- Internal Mesh Accessory Pocket
- Durable 38mm Webbing
- Multi Functional Daisy Web Details on Bag / Shoulder Straps



Lunch Box

Size: -
Color: ●

👉 Carry Forward



Gear Bag 2.0

Size: -
Color: ●

✳️ New



Snowboard Bags



Wheeled Board Bag

Size: 165cm
Color: ●

Dimensions: 165x20x33cm (65x7.9x13in)
Volume: 110L (6.713in³)

🛒 Carry Forward

TECHNICAL SPECIFICATIONS:

- Board Divider
- 2 Internal Board Straps
- 2 External Accessory Pockets
- Removable Boot Bag
- Internal Mesh Accessory Pocket
- Durable 38mm Webbing Handles for rolling Luggage with One Hand
- Durable and Replaceable External Oversized Wheels for Stability
- Full Circle / 3D Padded Protection
- #10 YKK Zipper
- Trifolds for Storage and Shipping

Snowboard Bag

Size: 157cm, 165cm
Color: ●

Dimensions: 160x15x35cm (64x6x13in)
157x15x35cm (61x6x13in)
Volume: 84L (5,125 in³)
82L (5,029 in³)

* New Size Available

TECHNICAL SPECIFICATIONS:

- Adjustable Shoulder Strap
- Fits Board with Bindings
- Water Resistant PU Interior
- #10 YKK Zipper
- Easy Packable for Storage

Expedition Accessories and Parts

Splitboard Climbing Skins Pro

Size: 148-156 / 156-168

Color: ● [Carry Forward](#)



Splitboard Climbing Skins

Size: 148-156 / 156-168

Color: ● [Carry Forward](#)



Touring Poles

Size: 110-135cm

Color: ● [Carry Forward](#)



Charger Heel Lifter Pro Kit

Size: OSFM

Color: ● [Carry Forward](#)

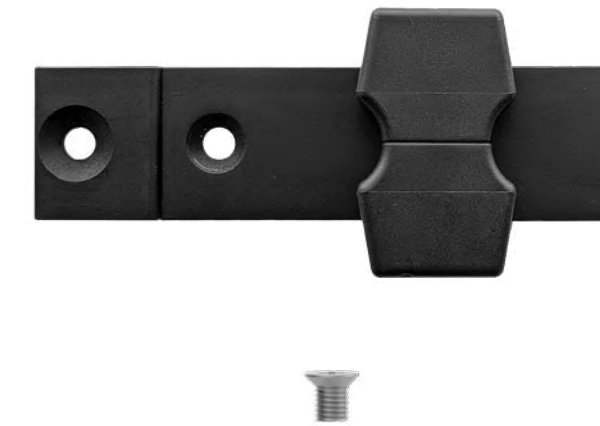

Serrated Crampon

Size: 160/140mm

Color: ● [Carry Forward](#)



Splitboard Strap - Velcro / Rubber

Size: OSFM

Color: ● [Carry Forward](#)



Rover Carbon / Approach Ski

Carry Forward

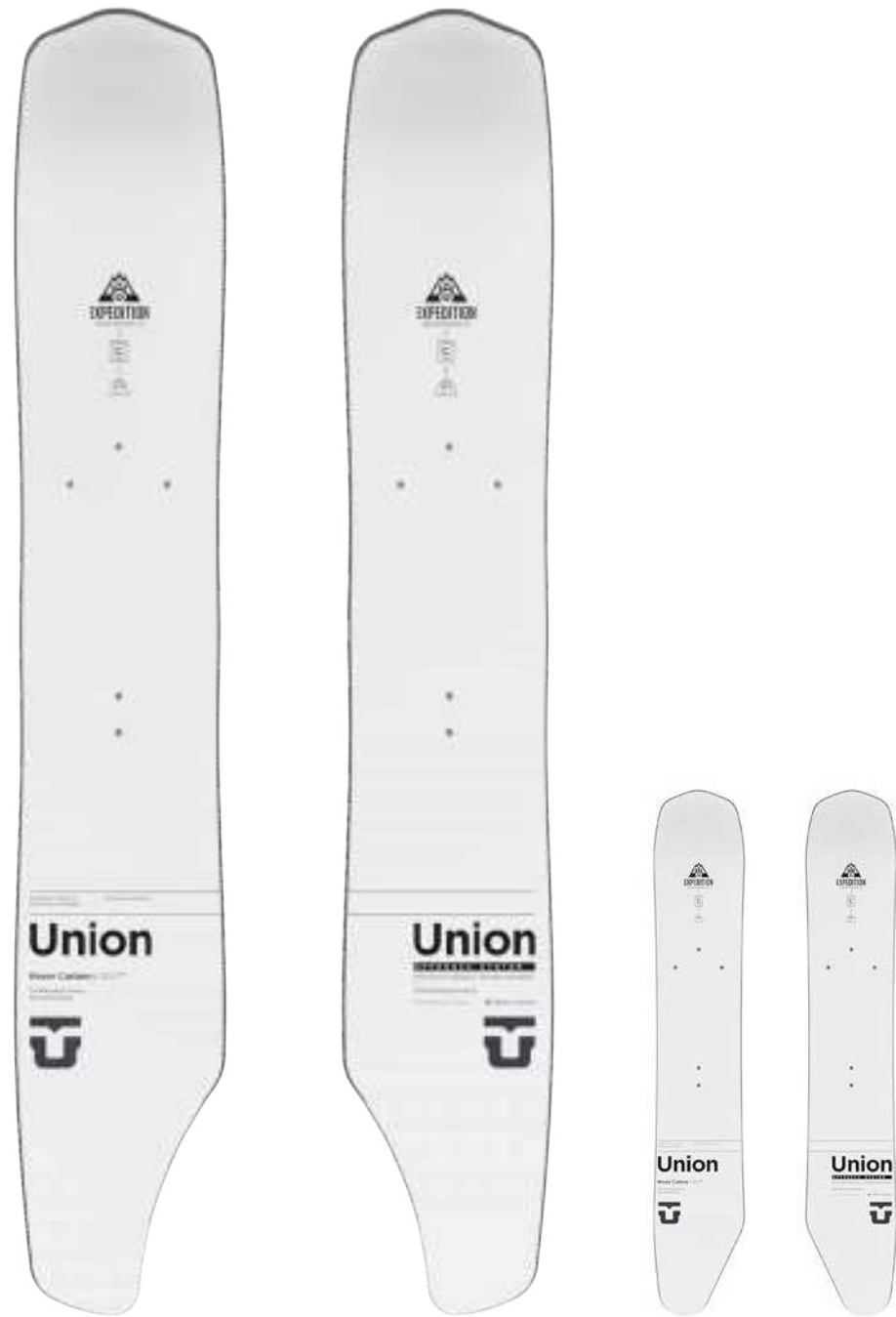

• Size: 100cm

• Size: 85cm

Technology		New
LENGTH:	100cm / 85cm	<input type="radio"/>
WIDTH:	152.5mm / 135mm	<input type="radio"/>
WOOD CORE:	FSC Certified Select Core	<input type="radio"/>
GLASS:	Special Blend Carbon Fiber + Magic Bean Resin	<input type="radio"/>
BASE:	Extruded Base	<input type="radio"/>
SIDECUT:	New Age Directional	<input type="radio"/>
CAMBER PROFILE:	Alpine V2	<input type="radio"/>
EDGES:	Steel	<input type="radio"/>
WEIGHT:	1600gr/pair - 1320gr/pair	<input type="radio"/>
CLIMBING SKIN:	Integrated-65% Mohair / 35% Nylon	<input type="radio"/>
COMPATIBILITY:	Voile / All Splitboard Bindings	<input type="radio"/>
CRAMPON WIDTH:	Rover 100 - 160mm / Rover 85 - 140mm	<input type="radio"/>

Rover Carbon / Approach Skis

The journey up just got even easier. Use Rover Carbon approach skis to save even more weight for your tour up, leaving you fresher legs for the ride down.

Flex: 9/10

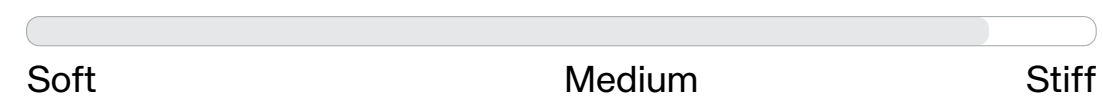

CAPITA Hand-Crafted in Austria at The Capita Mothership with 100% Clean Energy. +

Rover / Approach Ski

Carry Forward



• Size: 100cm

• Size: 85cm

Technology		New
LENGTH:	100cm / 85cm	<input type="radio"/>
WIDTH:	152.5mm / 135mm	<input type="radio"/>
WOOD CORE:	FSC Certified Select Core	<input type="radio"/>
GLASS:	Special Blend Carbon Fiber + Magic Bean Resin	<input type="radio"/>
BASE:	Extruded Base	<input type="radio"/>
SIDECUT:	New Age Directional	<input type="radio"/>
CAMBER PROFILE:	Alpine V2	<input type="radio"/>
EDGES:	Steel	<input type="radio"/>
WEIGHT:	2000 gr/pair - 1560 gr/pair	<input type="radio"/>
CLIMBING SKIN:	Integrated-65% Mohair / 35% Nylon	<input type="radio"/>
COMPATIBILITY:	Voile / All Splitboard Bindings	<input type="radio"/>
CRAMPON WIDTH:	Rover 100 - 160mm / Rover 85 - 140mm	<input type="radio"/>

Rover / Approach Skis

Explore your local hills, backcountry or closed resorts, all while enjoying the ridability of your favorite snowboard in your quiver. Rover approach skis are your key to unlocking new terrain.

Flex: 7/10

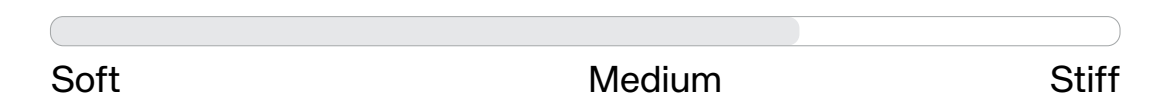

CAPITA Hand-Crafted in Austria at The Capita Mothership with 100% Clean Energy. +



Tools

#3 Screw Driver

Size: -
Color: ●

👉 Carry Forward



Pocket Tool

Size: -
Color: ●

👉 Carry Forward



Binding Multi Tool

Size: -
Color: ●●

👉 Carry Forward



Wall Mount Snowboard Holders

Size: -
Color: ●

👉 Carry Forward



Sawblade Keychain (3 PCS)

Size: -
Color: ●

👉 Carry Forward



Wax Scraper

Size: -
Color: ●

👉 Carry Forward

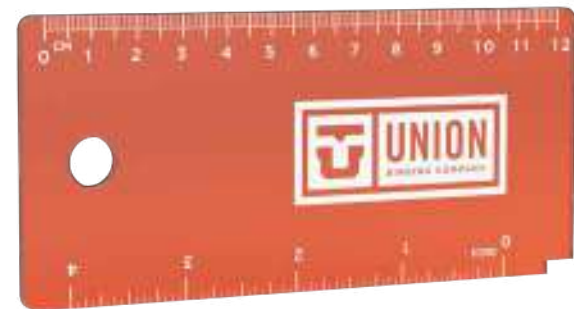

Stickers and Stomp Pads

U Diecut Sticker - 6.5 inch (10 PCS)

Size: 6.5 inch
Color: ●●○ [Carry Forward](#)



Union Box Logo Sticker - 8 inch (10 PCS)

Size: 8 inch
Color: ●●○ [Carry Forward](#)



UBC Diecut Sticker - 10 inch (10 PCS)

Size: 10 inch
Color: ●●○ [Carry Forward](#)



Multipack Sticker

Size: -
Color: [Carry Forward](#)



Union Classic Logo Sticker - 7 inch (25 PCS)

Size: 7 inch
Color: ● [Carry Forward](#)



Surf Stomp Pad

Size: 8 inch
Color: ●●○ [Carry Forward](#)



U Stomp Pad

Size: 4 inch
Color: ●●○ [Carry Forward](#)



Metal Stomp Pad (6 PCS)

Size: -
Color: ● [Carry Forward](#)



Lab Stomp Pad

Size: -
Color: ● [New](#)



Boot Scraper Stomp Pad

Size: -
Color: ●○ [New](#)



Replacement Parts

Exoframe 4.0 Ankle Strap

Size: M/L
Color: ●

👉 Carry Forward



TS 2.0 Ultragrip Toe Strap

Size: S, M/L
Color: ●

👉 Carry Forward



Alu S2 Ankle Ratchet

Size: -
Color: ●

👉 Carry Forward



Alu S2 Toe Ratchet

Size: -
Color: ●

👉 Carry Forward



Camber Disk

Size: -
Color: ●

👉 Carry Forward



Mini Disk (Threaded Insert)

Size: -
Color: ●

👉 Carry Forward



Ultra Mini Disk

Size: -
Color: ●

👉 Carry Forward



Universal Disk - V2

Size: -
Color: ●

👉 Carry Forward



Emergency Repair Kit

Size: -
Color: ●

👉 Carry Forward

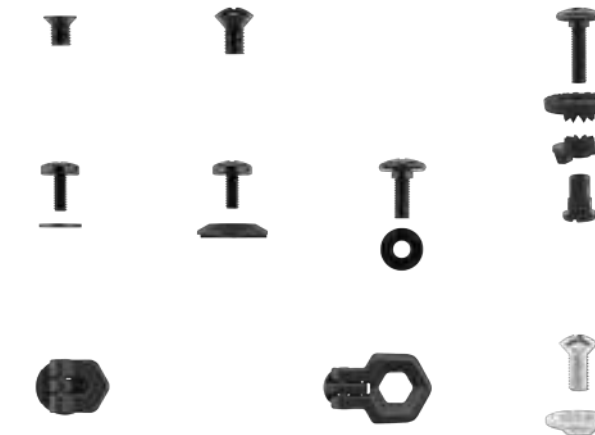

Mounting Hardware

Size: -
Color: ●

👉 Carry Forward



Replacement Parts

Highback to Ankle Strap Hardware

Size: -
Color: ● [Carry Forward](#)



Toe and Ankle Strap Tool-less Adjusters

Size: -
Color: ● [Carry Forward](#)



Classic Forward Lean Adjuster

Size: -
Color: ● [Carry Forward](#)



Ankle Sawblade

Size: -
Color: ● [Carry Forward](#)



Toe Sawblade & Toe Connector - New Gen.

Size: -
Color: ● [Carry Forward](#)



Toe Sawblade & Toe Connector - Old Gen.

Size: -
Color: ● [Carry Forward](#)



Dealer Bulk Parts

Exoframe 2.0 Ankle Straps (10 PAIRS)

Size: OSFM
Color: ●

👉 Carry Forward



Ultragrip Toe Straps (10 PAIRS)

Size: OSFM
Color: ●

👉 Carry Forward



Aluminum Toe Ratchet (36 PCS)

Size: OSFM
Color: ●

👉 Carry Forward



Aluminum Ankle Ratchet (24 PCS)

Size: OSFM
Color: ●

👉 Carry Forward



Gas Pedal Screw (100 PCS)

Size: OSFM
Color: ●

👉 Carry Forward



Mounting Hardware (100 PCS)

Size: OSFM
Color: ●

👉 Carry Forward



Universal Disk V2 (20 PCS)

Size: OSFM
Color: ●

👉 Carry Forward



Ankle Sawblade (20 PCS)

Size: OSFM
Color: ●

👉 Carry Forward



Mini Disk (20 PCS)

Size: OSFM
Color: ●

👉 Carry Forward



Camber Disk (20 PCS)

Size: OSFM
Color: ●

👉 Carry Forward



Dealer Bulk Parts

Toe Sawblade (20 PCS)

Size: OSFM
Color: ●

👉 Carry Forward



Toe Connector (20 PCS)

Size: OSFM
Color: ●

👉 Carry Forward

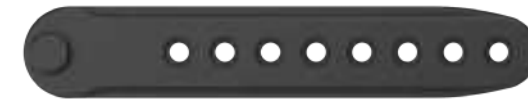

Ratchet Screw (100 PCS)

Size: OSFM
Color: ●

👉 Carry Forward



Toe Strap Tool-less Adjusters (50 PCS)

Size: OSFM
Color: ●

👉 Carry Forward



Ankle Tool-less Adjusters (50 PCS)

Size: OSFM
Color: ●

👉 Carry Forward



Highback to Ankle Strap Screw Set (15 BND SET)

Size: OSFM
Color: ●

👉 Carry Forward



UNION

SUPPORT



25.26





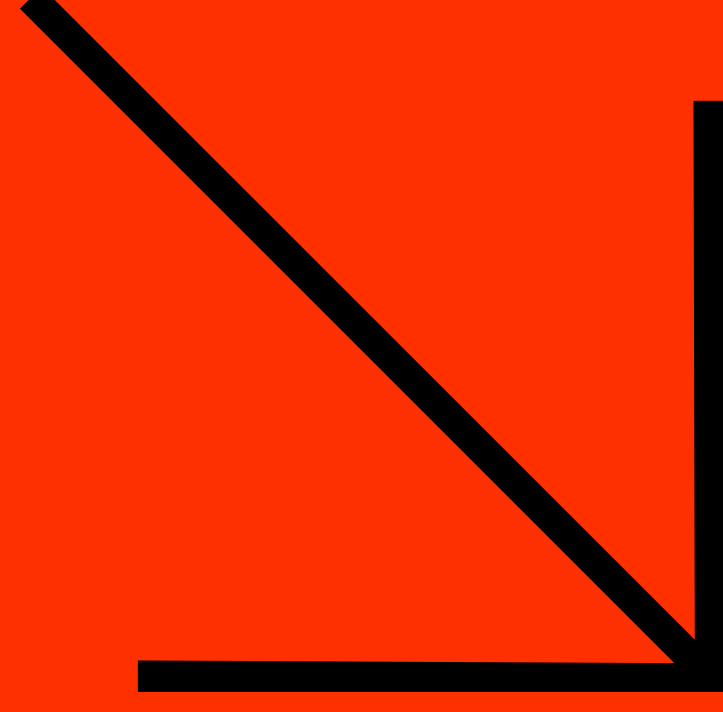



CORE SRL®
46°08-09-N 9°22-18-E
Via Colombano, 10
23014 Delebio SO, Italy



BOOT SIZE CHART

US MEN'S	5	5.5	6	6.5	7	7.5	8	8.5	9	9.5	10	10,5	11	11.5	12	12.5
US WOMEN'S	6	6.5	7	7.5	8	8.5	9	9.5	10	10.5	11	11.5	12	12.5	13	13.5
UK	4	4.5	5	5.5	6	6.5	7	7.5	8	8.5	9	9.5	10	10.5	11	11.5
EU	36.5	37	38	39	40	40.5	41	41.5	42	42.5	43	43.5	44	44.5	45	45.5
MONDO POINT	23	23.5	24	24.5	25	25.5	26	26.5	27	27.5	28	28.5	29	29.5	30	30.5

BOOT FEATURES

1 SHELL	2 LINER	3 FOOTBED	4 BUSHING SYSTEM	5 OUTSOLE	6 LACING SYSTEM	7 BOA®
						
Single Frame Shell™	Forma Pro Liner	Contact Footbed	Rebound Bushing System™	X-Grip Outsole	Dual Zone BOA®	BOA® Fit System Featuring H4 Series + TX3 Lace

BOOT MATERIAL GLOSSARY

UPPER ↘

Single Frame Shell™

Lightweight, super durable, waterproof Pebax material provides a reactive flex pattern while snowboarding and maintains its performance over the boot's lifecycle.

HF Premium Synthetics

Union's HF Premium Synthetic materials are wear resistant with welded construction for the utmost durability. All materials are locally sourced in Italy.

Tapered 3D Tongue

Union's Tapered 3D Tongue uses geometric shaping for comfort and provides increased room in toe box.

LINER ↘

Forma Pro Liner

This 100% custom-made memory foam liner form fits any foot out of the box and provides the support and performance that riders need for multiple 100+ day seasons.

Quick-Lock Lace Harness

Union's Quick-Lock Lace Harness is mitt / glove friendly and allows you to easily adjust tightness to distribute pressure evenly across your foot.

EPDM Ankle Pocket

Made with Ethylene Propylene Diene Monomer—a synthetic rubber material that acts as a cushioned memory foam to help lock in your heels and provide additional ankle support.

Heat Reflective Foil

Heat Reflective Foil is used to redirect heat underfoot and keep you riding for longer on those extra cold days.

UNDERFOOT ↘

Contact Footbed

Dual Density Ortholite™ footbeds are made with made with 5% recycled rubber and deliver a combination of performance and comfort unmatched by any insole manufacturer.

Rebound Bushing System™

Union's Rebound Bushing System™ adds an additional layer of lightweight cushioning under your heels and toes to help reduce vibrations for the snow and eat up heavy impacts while riding. This unique layer of rebounding foam helps to reduce foot fatigue and never loses shape or performance over time.

X-Grip Outsole

Durable, high performance natural rubber provides excellent grip on snow and ice. Made to last.

LACING ↘

Dual Zone BOA®

Dual Zone BOA® lacing offers premium all mountain performance with two separate micro-adjustable zones.

BOA® Fit System Featuring H4 Coiler™ + H4

Rigorously tested and trusted. The BOA® Fit System featuring Dual-Dial H4 delivers revolutionary durability, micro-adjustable, precision fit, and fast release.

BOA® TX3 Lace

The workhorse of the BOA® Fit System. Flexible and low-friction, the BOA® textile TX3 lace delivers high strength-to-weight ratio.

BINDING SIZE CHART

CROSSOVER SIZING ▾

MEN'S / UNISEX

		XS	S	M	L	XL
US MEN		* - 5.5	5.5 - 7.5	8 - 10	10.5 - 13	13 - 15
US WOMEN		4 - 6.5	6.5 - 8.5	9 - 11	-	-
US KIDS		3K - 5.5K	5.5K+	-	-	-
UK		2 - 4.5	4.5 - 6.5	7 - 9	9.5 - 12	12 - 14
EURO		34 - 37	37 - 40.5	41 - 43	43.5 - 46	46 - 48
MONDO		21 - 23.5	23.5 - 25.5	26 - 28	28.5 - 31	31 - 33

WOMEN'S

		S	M	L		
US MEN		* - 5.5	5.5 - 7.5	8 - 10		
US WOMEN		4 - 6.5	6.5 - 8.5	9 - 11		
US KIDS		3K - 5.5K	5.5K+	-		
UK		2 - 4.5	4.5 - 6.5	7 - 9		
EURO		34 - 37	37 - 40.5	41 - 43		
MONDO		21 - 23.5	23.5 - 25.5	26 - 28		

KIDS

	ONE	MINI	S	M		
US MEN	-	-	* - 5.5	5.5 - 7.5		
US WOMEN	-	* - 4	4 - 6.5	6.5 - 8.5		
US KIDS	7C-11C	11C - 3K	3K - 5.5K	5.5K+		
UK	6-10	10K - 2	2 - 4.5	4.5 - 6.5		
EURO	24-28	28 - 34	34 - 37	37 - 40.5		
MONDO	13.5-17.5	17.5 - 21	21 - 23.5	23.5 - 25.5		



DISK GUIDE

SNOWBOARD BINDINGS

SPLITBOARD BINDINGS



01.

Camber Disk

COMPATIBILITY:
4X2, 4X4, Channel

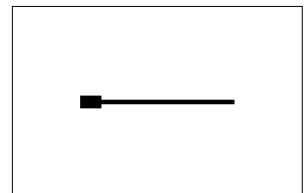
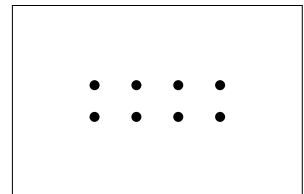
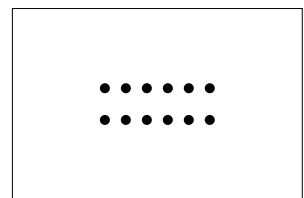

02.

Universal Disk V2

COMPATIBILITY:
4X2, 4X4, Channel, 3D

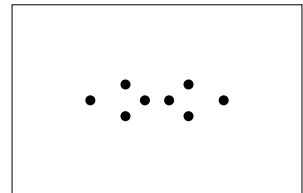
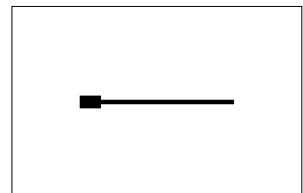
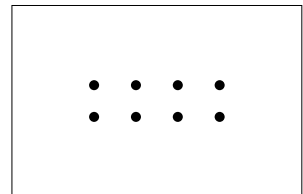
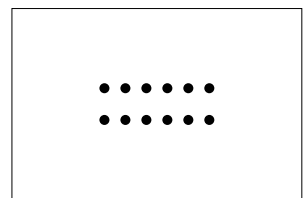

03.

Mini Disk

COMPATIBILITY:
4X2, Channel

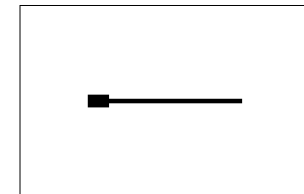
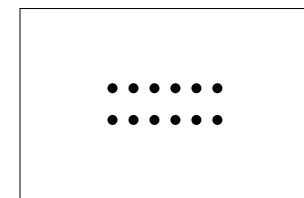

04.

Step On® 4x2 Disk

COMPATIBILITY:
4X2

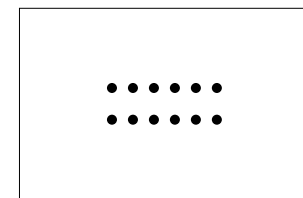

05.

Step On® Channel Disk

COMPATIBILITY:
Channel

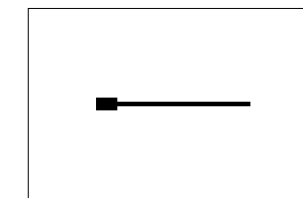

07.

Explorer Split Disk

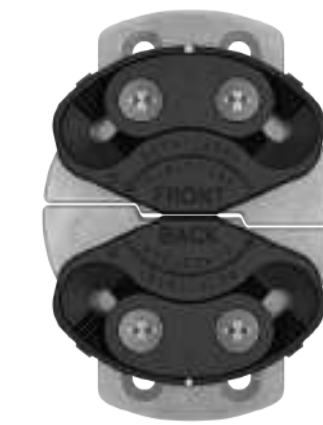

09.

Charger Split Disk

COMPATIBILITY:
Voile Split

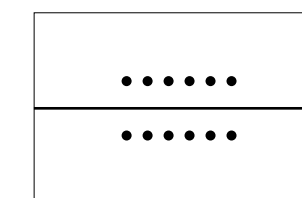

08.

Explorer Quiver Disk



10.

Charger Quiver Disk

COMPATIBILITY:
4X2

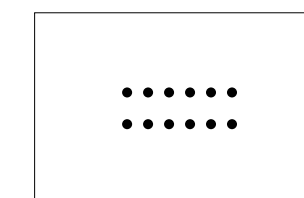

06.

Direct Connect System

COMPATIBILITY:
4X2

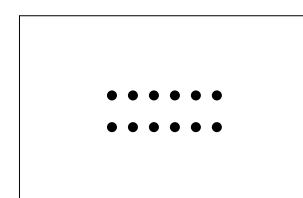

BINDING MATERIAL GLOSSARY

PLASTICS / COMPOSITES ▾

Duraflex XB

Duraflex XB is Union's most technical nylon material to date. Stiff, responsive and super lightweight, this carbon injected partially sustainable nylon is made by steaming castor bean oil.

Duraflex Blue

Duraflex Blue nylon is made with 90% sustainable raw materials and is audited and certified by ISCC and TÜV Nord. This is Union's first partially sustainable nylon material made from a mass-balance feedstock.

Duraflex CB

Duraflex CB nylon uses Union's highest amount of fiber glass and is considerably lighter, stiffer and more responsive than our Daraflex ST material.

Duraflex ST

Simply put, Duraflex ST is the same material as regular Duraflex, but with increased fiber glass for more response without the weight. Designed for cold temperatures.

Duraflex

Duraflex material was specifically engineered to maintain consistent flex in a wide range of cold temperatures. Exclusive to Union for snowsports products.

Forged Carbon

Exclusive to Union, Forged Carbon exceeds the strength requirements of injected plastic tenfold and is the only carbon material that can be truly 3D shaped.

BUSHINGS ▾

Molecular

More durable and more cushioned than traditional thermoformed EVA, Molecular bushing materials acts as a suspension system between the baseplate and the boards top sheet, to help reduce vibrations from harsh snow pack.

Vaporlite HD

High Density Vaporlite maintains the same dampening properties as traditional Vaporlite, but is more responsive and durable.

Fused Vaporlite +

20% lighter than the original and still just as water proof, durable and vibration cancelling.

Fused Vaporlite

Fused Vaporlite sets new standards for vibration dampening and natural board flex. Industry first.

Thermoformed EVA

Shock absorption saves your heels and promotes a true and even board flex.

Non-Stick EVA

Non-Stick EVA sheds water and snow like nothing you've experienced before. Gone are the days of icy build up under your boots.

METALS ▾

Extruded Aluminum

Extruded aluminum is 100% pure and maintains its true shape no matter how much wear and tear you inflict upon it.

Magnesium

This Union exclusive process produces a material four times the strength of aluminum with only half the weight.

Grade 8.8 Steel

The strongest steel available on the market. Our use of grade 8.8 represents our commitment of delivering the strongest and most reliable bindings on the market today.

Titanium

Titanium is a lightweight, high-strength, low-corrosion metal used for hardware on select Union models.

STRAP MATERIAL ▾

Hytrel

Hytrel combines the flexibility of rubber with the strength and processability of thermoplastics.

S.E.B.S.

Thermoplastic anti-slip rubber webbing keeps your boots locked in and on point.

Lycra Layered EVA

Lycra layered EVA is lightweight, durable and form fits any boot make and model.

PU Layered EVA

PU layered EVA is waterproof, super durable and form fits any boot make and model.

WARRANTY

THE UNION GUARANTEE ↘

Union is proud to use the highest-grade materials available on every single product that we produce. Wherever you see the "U" logo, you can have the confidence that no sacrifices have been made.



All Union products are covered against defects in materials or workmanship for one year from the date of purchase (two-year coverage in EU). Binding baseplates and heelcups are covered for the lifetime of the product.



INSTALLATION GUIDE

WE'VE GONE DIGITAL ↘

Setting up bindings just got even easier. The Union digital installation guide is a step by step online guide to help customers get the perfect boot-to-binding fit everytime.

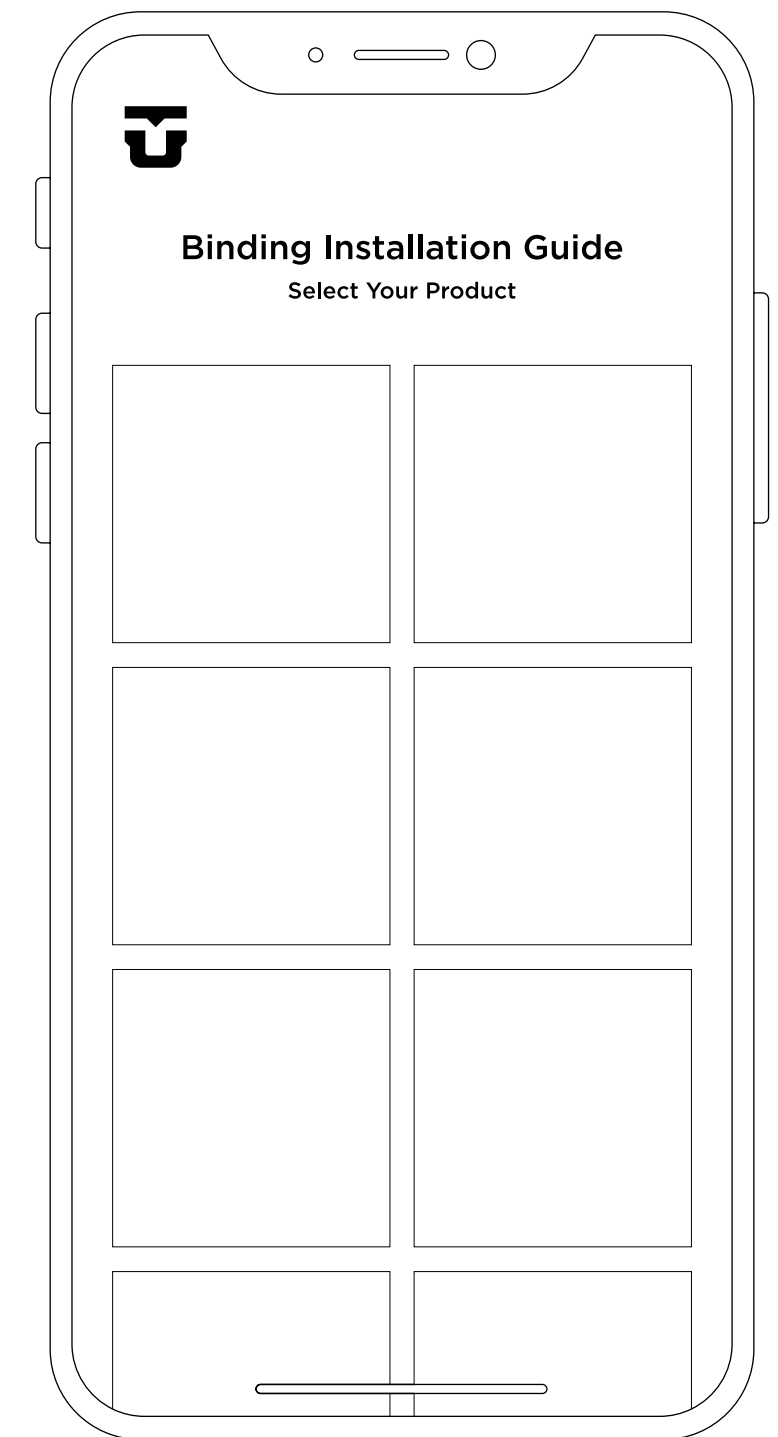

CONTACT

1 WEB

1.

Web

Discover more about Union Binding Company and Union Boot Division by visiting our websites.

 www.unionbindingcompany.com

 www.unionbootdivision.com

2 ELASTIC

2.

Elastic

Catalogs, order forms and current inventory can all be found on the Union Elastic suite.

www.unioncapita.elasticsuite.com

elastic

3 SOCIAL

3.

Social

Keep up with all of the latest from Union by following our social media.

 [@Unionbindingco](#)

 [@Unionbindingco](#)

 [Union Binding Company](#)

UBD ↘

· RESET PRO



Lab ↘

· SOURCE FC



· SOURCE PRO



Step On® ↘

· ATLAS STEP ON®



Performance ↘

· FALCOR



· ATLAS PRO



· ATLAS



All Mountain ↘

· FORCE



· TRILOGY



· STR



· JULIET



Classics ↘

· FORCE CLASSIC



· TRILOGY CLASSIC



Freestyle ↘

· ULTRA MENS



· ULTRA WOMENS



· STRATA



· LEGACY



· FLITE PRO



· ROSA



· FLITE



Kids ↘

· CADET PRO



· CADET



· CADET MINI



· CADET ONE



Expedition ↘

· CHARGER PRO



· CHARGER



· EXPLORER



Rental ↘

· RENTAL



